

## VHF-LO Larcan Amp Conversion to VHF-HI Band (Amateur 2m band) Brian Justin, WA1ZMS

The VHF-LO Larcan amps are based on 175MHz RF transistors. They *can* be modified to operated on the 2m band. The modifications are more substantial than those for the “lo-hi” to “lo-lo” conversion, but are still relatively easy to perform.

Each Larcan amp assembly consists of an input splitter, 4 pairs of input and output PC boards, and an output combiner.

With these modificatons, each amp stage by itself should give approximately 300w out for about 6w of drive at 144.200MHz, for a total module power out of 1200W.

For 20W drive, the amp will produce 1050W on 144.200MHz. DC current draw is 45 amps at 50VDC. This gives a DC input power of 2250w. With 1050w output power, the resulting efficiency is: 44%. Not too bad for a linear amp. Future 2-tone IMD and pin vs.  $P_{out}$  curve data will give a better view of the true SSB performance of the amp. For FM or CW beacon operation, 2-tone IMD is unimportant. You could use the amp as-is without further testing. A quick check of RF output at the front panel sample port showed no spurious output signals. A low-pass filter will be required for actual on-air use.

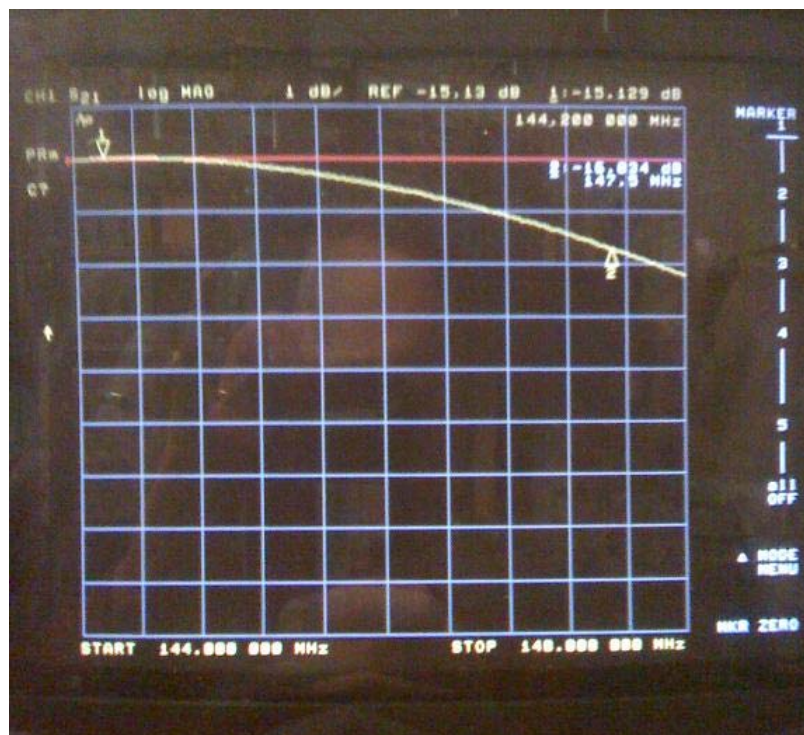

Gain vs. Frequency  
17.2dB @ 144.2 Mhz, drops to about 16dB @ 147.5 Mhz

Modifications are needed to the splitter, combiner, and each of the amp-pairs.

#### Input Splitter:

This board is a unique and clever design by Larcan as it is not your typical standard 1/4-wave 75ohm 2-way splitters. But that's another story. The input splitter has all new cap values, a new value coil for the center splitter and the addition of two new series inductors located near the first splitting node. All the coils are standard value Coilcraft spring wound inductors. Another mod to the input splitter is a low impedance grounding strap (shown made from copper foil) that ties one of the shorting stubs to ground at a shorter length.

#### Amplifier input PC boards and output PC boards:

Each input PCB gets 2 shorting straps added, and all new ATC caps values, including one additional cap.

Each output PCB gets 2 shorting straps added to the ones already in the amp. All new cap values as well as one additional cap added.

DC bias is set for 150mA per side of RF device. Changing the bias value will change the input match of the amp stage and could result in poor input SWR. So I recommend 150mA per side of each device since that is a typical value used in other MRF151G amps that I have designed.

#### Output Splitter:

The output splitter is a copy of the input modifications with the same new inductors added as well as all new cap values. A similar short-to-ground strap is shown in the upper left area of the combiner PCB.

#### RF Connectors:

I modified this amp to use an SMA input connector and a standard type-N for the output. The input connector must be changed since the bus wire in the original design is too inductive for use at 144MHz. I also added caps in series with the SMA as you can see in the pix but they are not needed and were only there for my testing and verification of the new circuits.

#### Additional Comments:

Retuning the amps was the easy part, I learned the most by reverse engineering the splitter boards. Although drawn as simple Wilkinson splitters in the Larcan documentation, the line lengths and impedance values are not what one would expect. I think that's why they are not called out in their documents. For example: the splitters use 30deg long 100ohm lines rather than the usual 90deg 75ohm lines. In circuit simulation it has some advantage as giving better bandwidth over the 12MHz design spec for the amp.

### Operating the amp at a slightly higher frequency:

Although the gain is fairly flat across 144-147 Mhz, the input splitter is fairly narrow and the return loss curve is quite sharp:



A hairpin loop of #22 solid wire from the input trace to ground, can be used as an impedance match to move the notch . You can still get over 900W out with 20w of drive @ 147.5 Mhz.

For this simple extra modification, use a 1.75" long piece of bare #22 wire (a component lead clipping might work just as good) tapping the input RF trace of the complete amplifier to ground. I tapped the input trace 4.6" away from the input SMA connector. Then just brought the wire to chassis ground. When done, it looks like a little horse shoe from the trace to ground. You can play around with the hairpin's length and location somewhat to get the input match just about flat on any freq you desire. But even without the hairpin at all, I was able to get 800w out with 20w of drive and no extra tuning at 147.5MHz. The only thing stopping the amp from higher power as-is, is the SWR that the amp presents to whatever is driving the amp.

The bandwidth limit is really the input side of the amp and not so much as the output side.

Additional Photos:

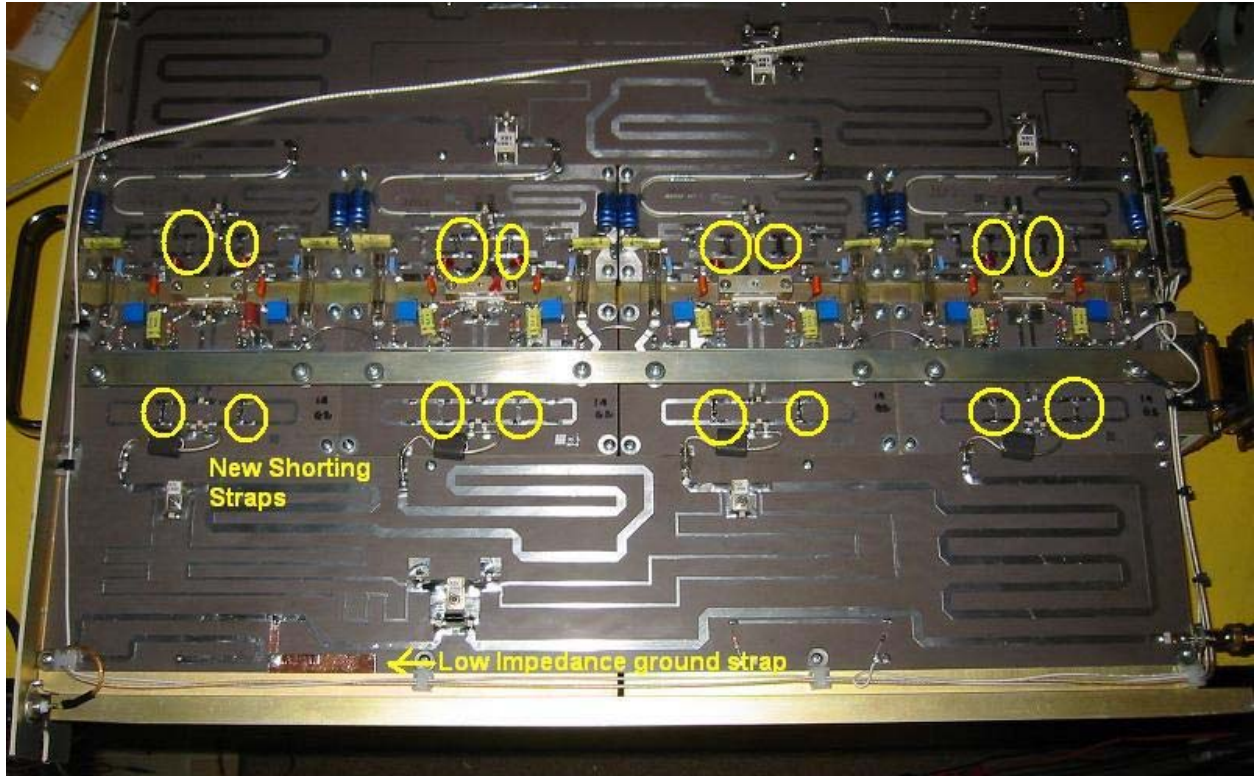

Showing the location of the new shorting straps and low impedance ground strap

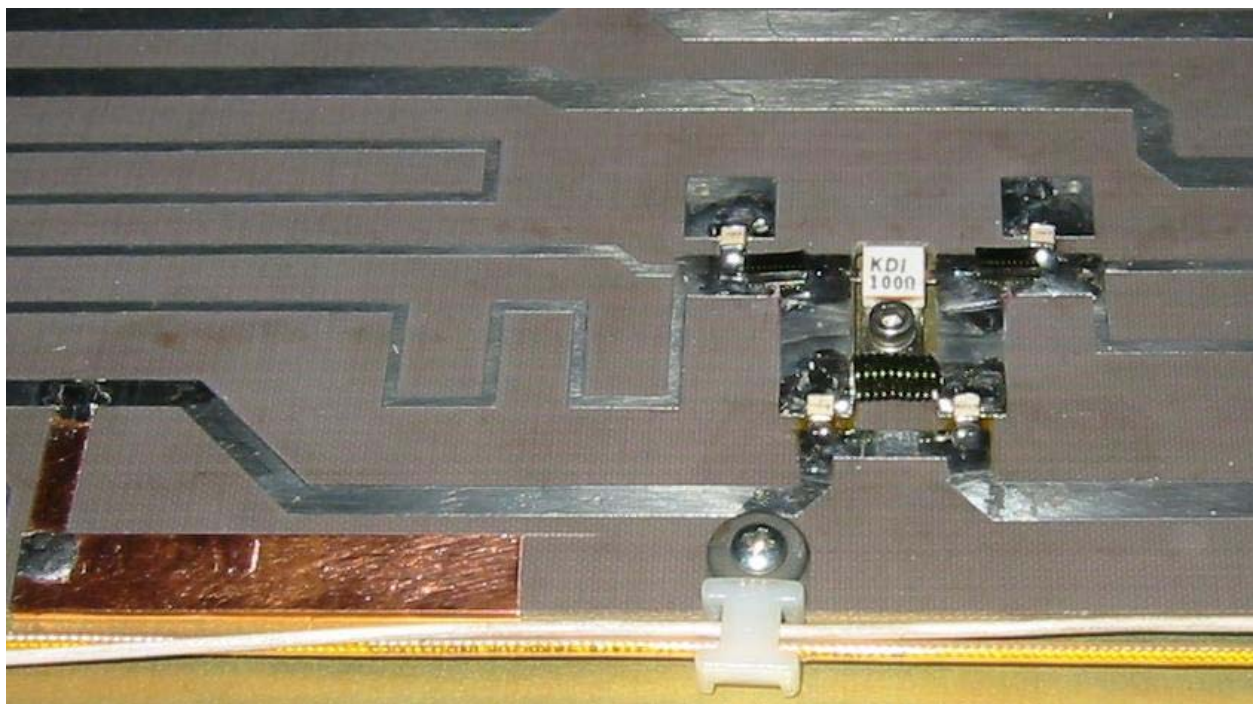

Closeup of the grounding strap and the new coils on the input splitter

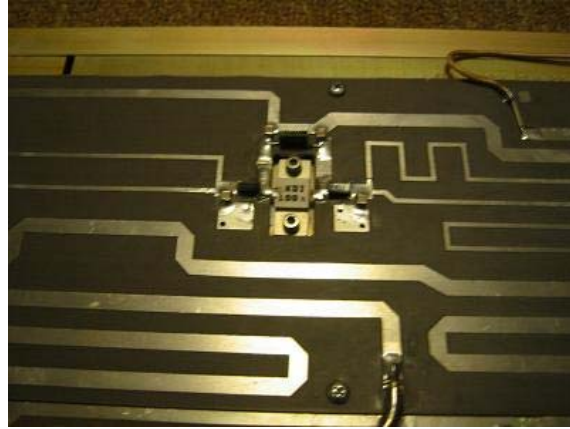

New Coils on Output Combiner



new RF connectors on input (left) and output (right)

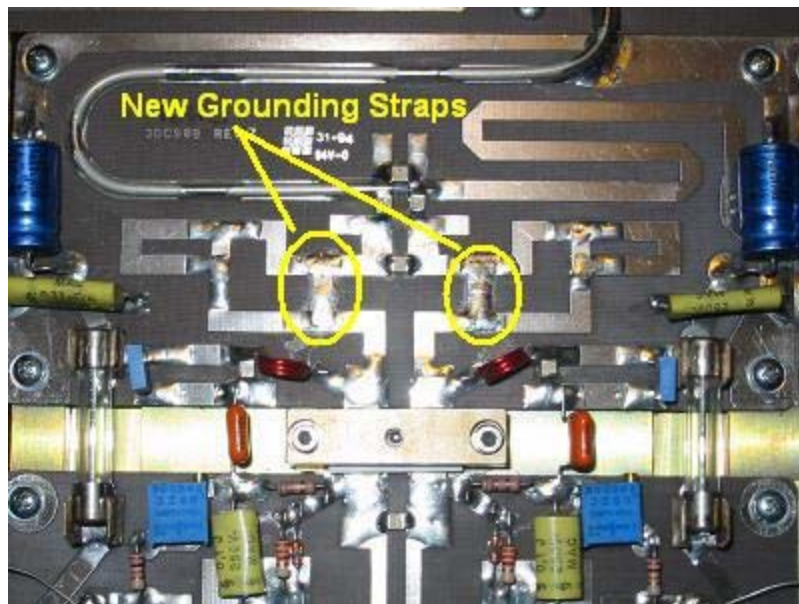

Closeup of the output PC mods

Existing grounding straps further out exist on VHF-lo-hi models but not on VHF-lo-lo models

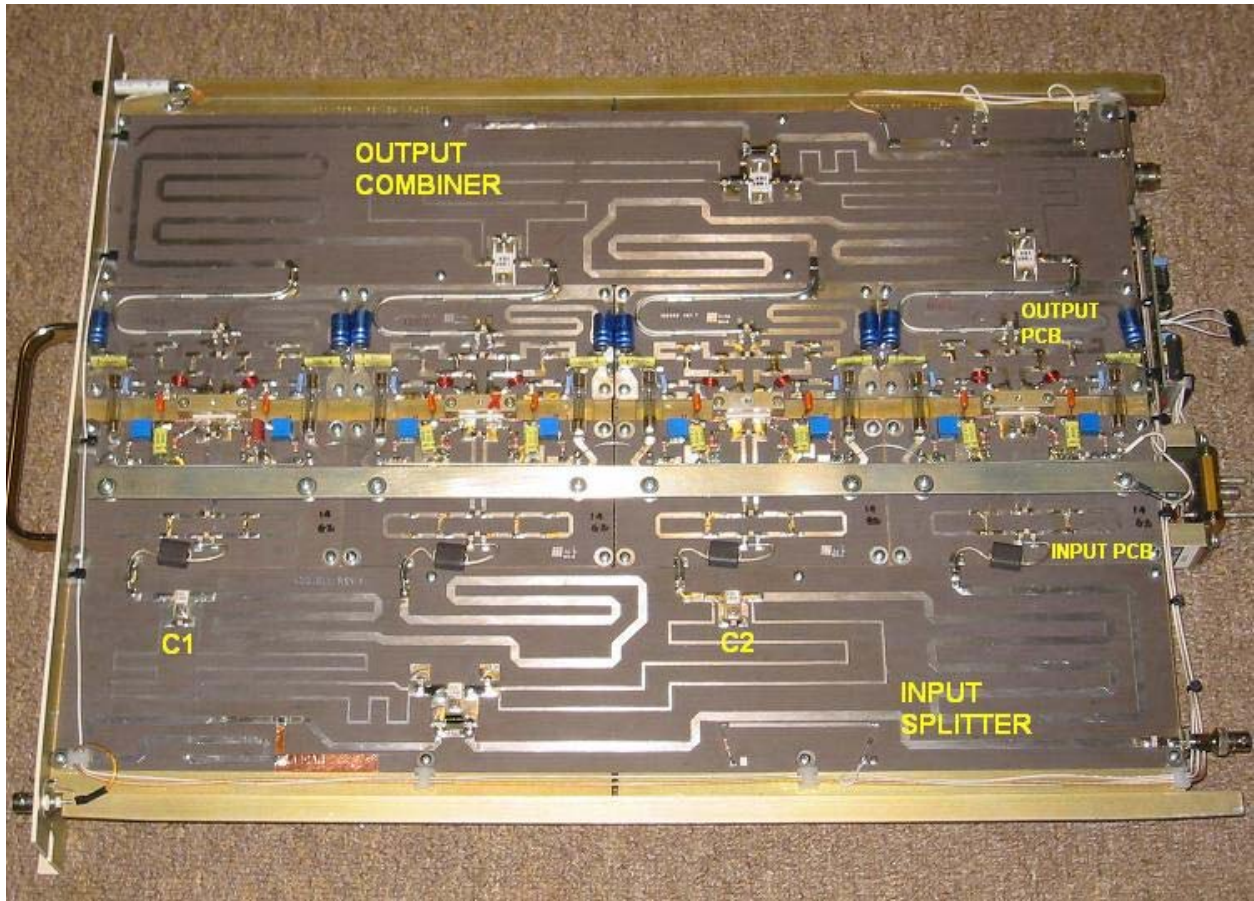

overview of module shows location of each board as well as location of C1 and C2 on the input splitter

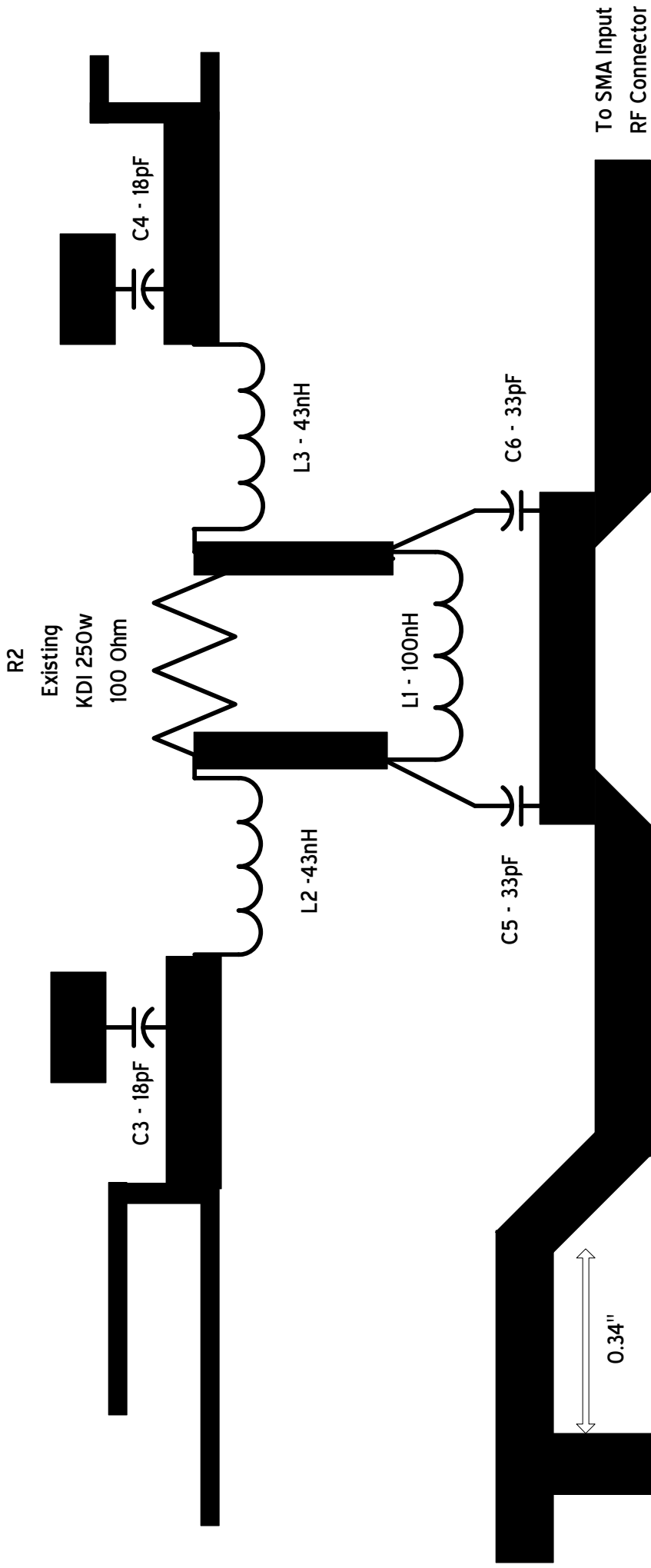

Added  
0.150" wide  
Strap, edge  
wrapped to  
ground side of  
PCB.

0.34"

**4-way Input Splitter PCB**

Larcan 70MHz Module  
Conversion for use on  
144MHz.

de WA1ZMS & MMRA  
Jan 2010 Rev A

- C1 – 3.3pf ATC100B (not shown)
- C2 – 3.3pf ATC100B (not shown)
- C3 – 18pf ATC100B
- C4 – 18pf ATC100B
- C5 – 33pf ATC100B
- C6 – 33pf ATC100B
- L1 – 100nH Coilcraft 132-10SM
- L2, L3 – 43nH Coilcraft B10T

NOTE – RF Trace must be cut to install L2 & L3.

**NOT TO SCALE!**

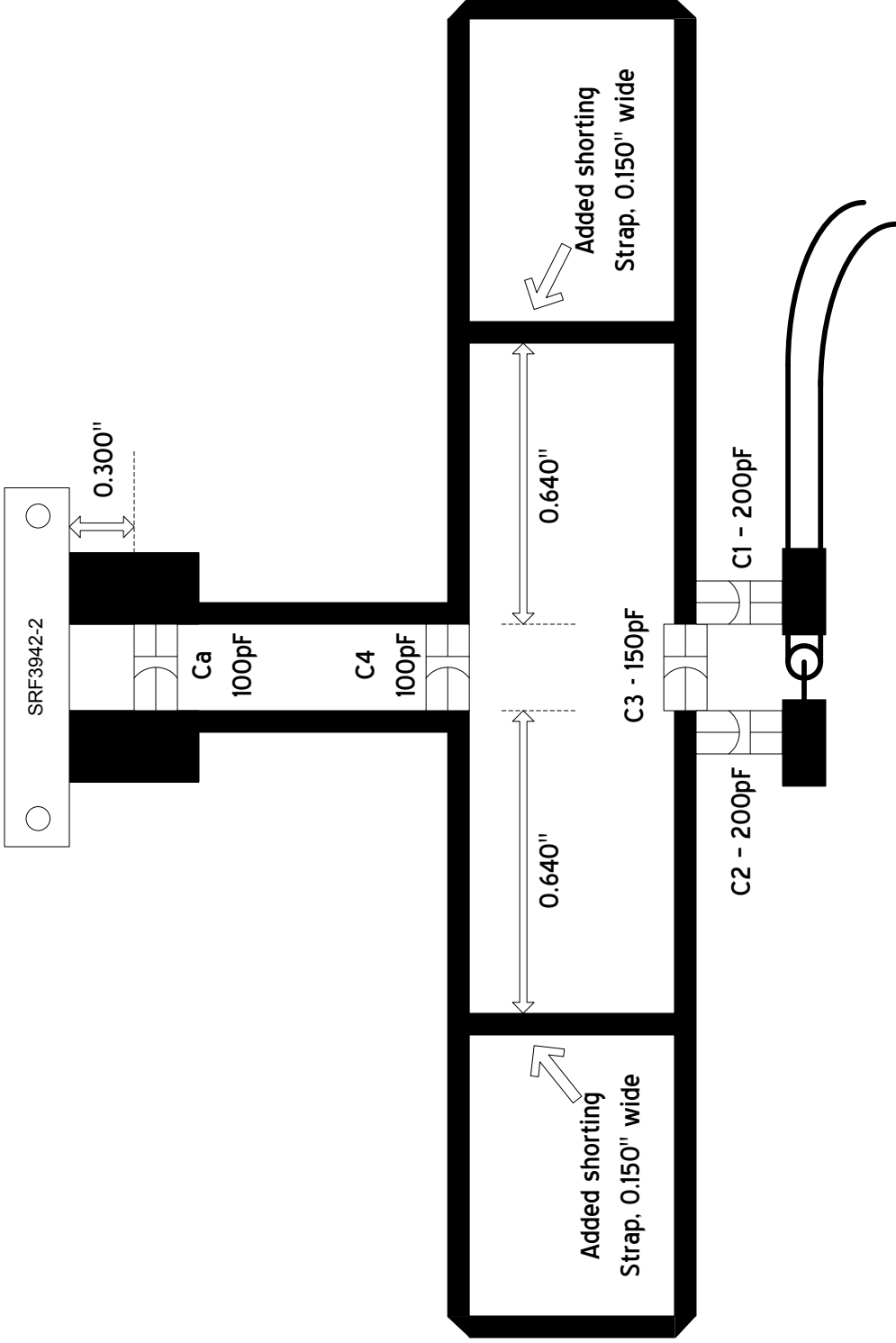

**Amp Stage Input PCB**  
**Larcan 70MHz Module**  
**Conversion for use on**  
**144MHz.**  
**de WA1ZMS & MMRA**  
**Jan 2010 Rev A**

- C1 – 200pf ATC100B
- C2 – 200pf ATC100B
- C3 – 150pf ATC100B
- C4 – 100pf ATC100B
- Ca – 100pf ATC100B (added part)

**NOT TO SCALE!**



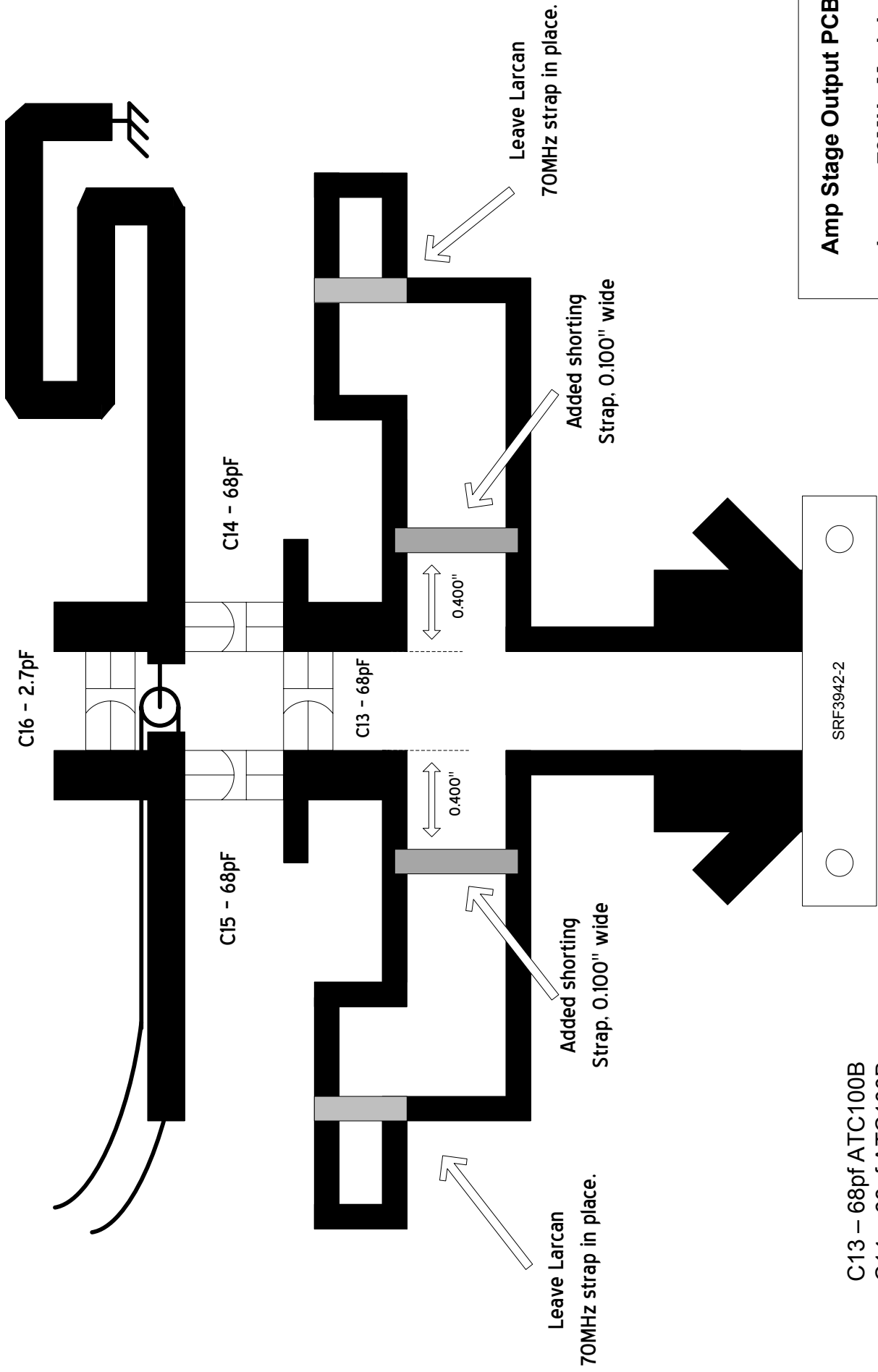

**Amp Stage Output PCB**  
 Larcan 70MHz Module  
 Conversion for use on  
 144MHz.

de WA1ZMS & MMRA  
 Jan 2010 Rev A

- C13 - 68pf ATC100B
- C14 - 68pf ATC100B
- C15 - 68pf ATC100B
- C16 - 2.7pf ATC100B

**NOT TO SCALE!**

New Wide  
Shorting Strap  
to Gnd

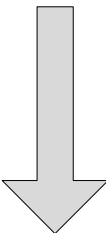
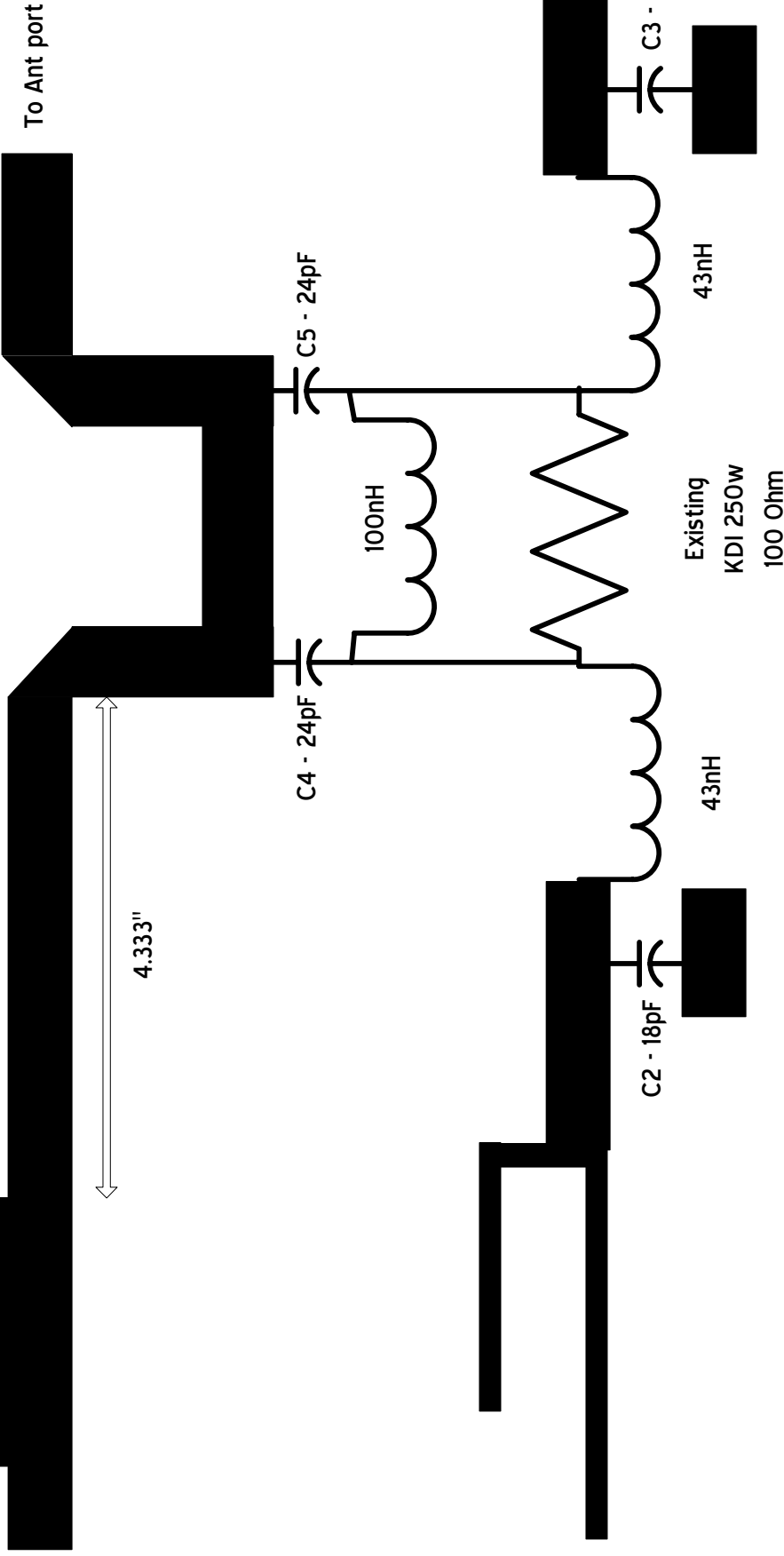
#### 4-way Output PCB

Larcan 70MHz Module  
Conversion for use on  
144MHz.

de WA1ZMS & MMRA  
Jan 2010 Rev A

C1 – 3.3pf ATC100B (not shown)

C2 – 18pf ATC100B

C3 – 18pf ATC100B

C4 – 24pf ATC100B

C5 – 24pf ATC100B

C8 – 3.3pf ATC100B (not shown)

L1 – 100nH Coilcraft 132-10SM

L2, L3 – 43nH Coilcraft B10T

NOTE – RF Trace must be cut to install L2 & L3.

**NOT TO SCALE!**