

**PORSCHE**

**914/4 AIR CONDITIONER**

**INSTALLATION INSTRUCTIONS**

# A/C INSTALLATION PORSCHE 914/4

---

## Contents

- 1 – 1 Suggested Tool List
- 2 – 1 Preparation
- 3 – 1 Engine Compartment
- 4 – 1 Hoses
- 5 – 1 Condenser
- 6 – 1 Wiring
- 7 – 1 Evaporator
- 8 – 1 Completion

# A/C INSTALLATION PORSCHE 914/4

---

## PORSCHE 914/4 SUGGESTED TOOL LIST

- 1) Vacuum pump
- 2) Manifold gauge set (with hoses)
- 3) 28 oz. of Refrigerant 12
- 4) Refrigeration oil
- 5) Eye goggles
- 6) Leak detector
- 7) Template ZPW214744 (included with unit)
- 8) Template ZPW214745 (included with unit)
- 9) 1-1/4" Knock-out punch
- 10) Hole saws
  - a) 3/4"
  - b) 1-1/4"
- 11) Drill bits
  - a) 1/8" (No. 30 or 3mm)
  - b) 1/4" (6mm)
  - c) 1/2" (13mm)
- 12) Sabre saw and metal blades
- 13) Drill motor
- 14) Left and right hand sheet metal shears
- 15) 3/8" drive ratchet
- 16) Sockets
  - a) 10mm
  - b) 13mm
  - c) 3/8"
  - d) 5/16"
  - e) 1/2"
  - f) 12-point internal (VW990-12)
- 17) Open end wrenches
  - a) 10mm
  - b) 5/16"
  - c) 3/4"
  - d) 7/8"
  - e) 1"
  - f) 1-1/8"
- 18) 6mm allen wrench
- 19) Phillips and slot screwdrivers
- 20) Oil filter tool (VW 1017)

# A/C INSTALLATION PORSCHE 914/4

## PREPARATION

BEFORE BEGINNING INSTALLATION, VARIOUS COMPONENTS NEED TO BE REMOVED OR MODIFIED AND HOLES WILL NEED TO BE DRILLED FOR HOSE AND WIRING PASSAGES.

### A. Front Luggage Compartment

- 1- Remove spare tire and cover.
- 2- Remove windshield washer bottle and lay to the side.
- 3- Remove right front wheel.

### B. Passenger Compartment

- 1- Remove center console.
- 2- Remove tunnel and driver's side floor-mats.
- 3- Lift up kick panel in front of pedal cluster.
- 4- Remove both inspection plates from tunnel to gain access to wiring.
- 5- Disconnect trip odometer cable at dashboard. Retain the nut, washer and knob.
- 6- To the outside of the right step plate, there are six nylon rivets above the rocker panel. Remove these rivets.

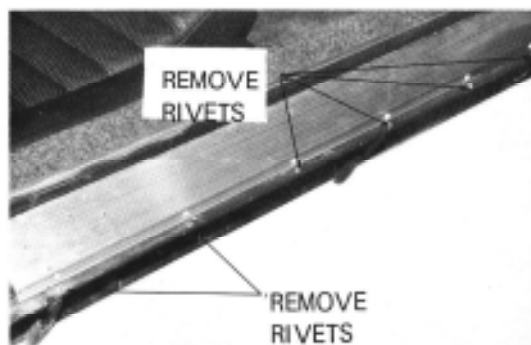

- 7- Remove right rocker panel.

### C. Engine Compartment

- 1- Disconnect and remove battery.
- 2- Remove and discard timing access plug.
- 3- Remove right side fresh air heater hose between blower motor and vertical heater duct.

- 4- Remove fuel injection control box and move towards rear out of the way. Do not disconnect electrically. Discard the brackets but retain the two screws.

- 5- Remove air cleaner. Disconnect throttle cable and pull back through hole in sheet metal.

- 6- In front of the engine, there is a sheet metal panel secured by seven screws. Remove the panel.

- 7- Disconnect air hose which is connected to the upper right side of the air intake housing. Remove the original connecting stub.

# A/C INSTALLATION PORSCHE 914/4

8- Raise the car and remove the fresh air heater pipes beneath the right side of the car. Three pipes, one hose and a panel will be removed.

a)

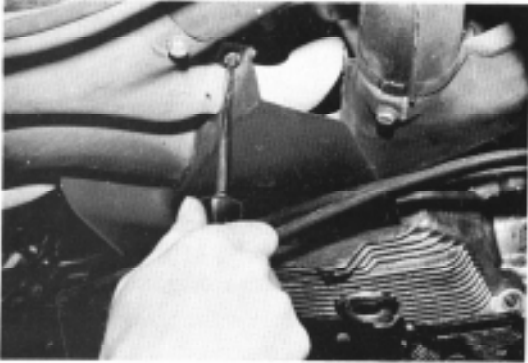

b)

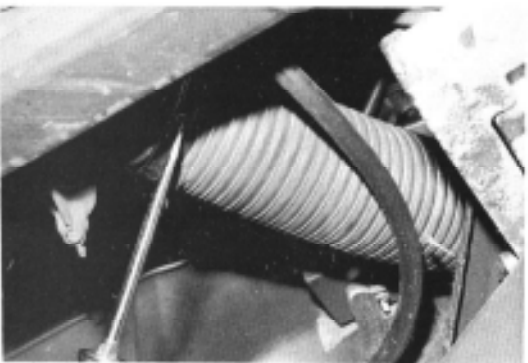

c)

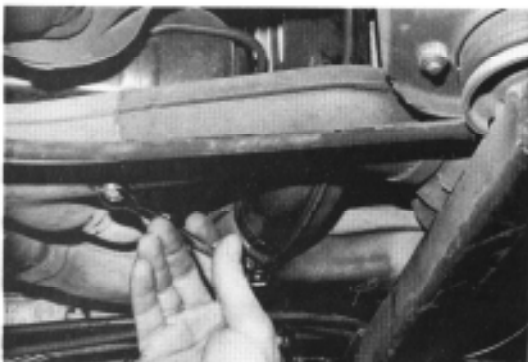

(see top of page)

d)

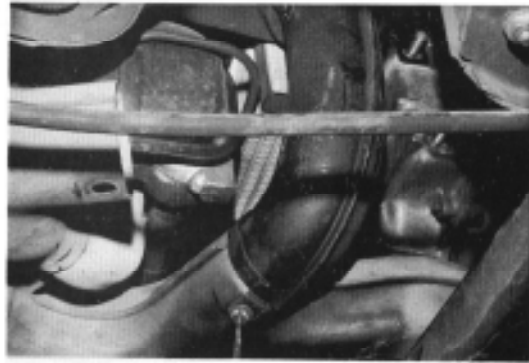

e)

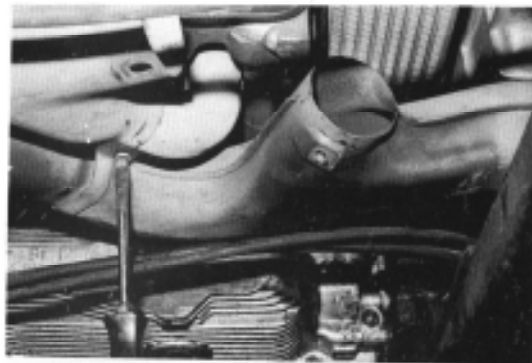

9- Remove oil filter.

# A/C INSTALLATION PORSCHE 914/4

- 10— Remove and discard three 8mm nuts beneath the oil filter base.

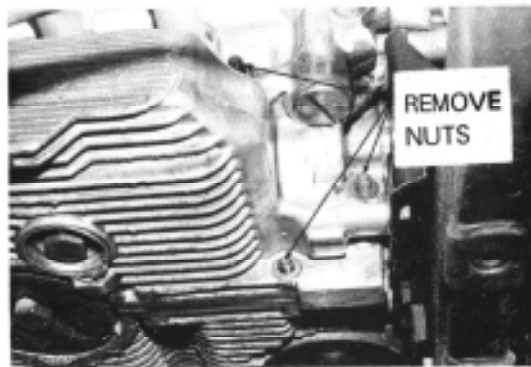

- 11— Remove and discard the 8mm bolt which secures the oil cooler bracket on the right side of air intake housing.
- 12— Loosen the alternator and remove belt.
- 13— Remove the three bolts securing the impeller and remove the impeller. Discard the washer behind the impeller.
- 14— Modify the existing sheet metal panel on the right side of the engine as shown. The cross-hatched area in the illustration will be removed.

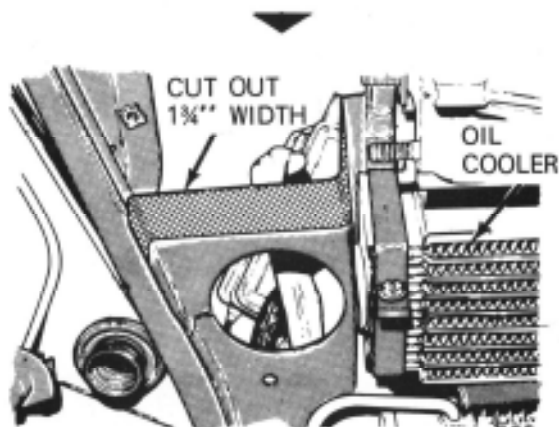

- 15— Modify the panel forward of the panel cut in the previous step. The cross-hatched area in the illustration will be removed.

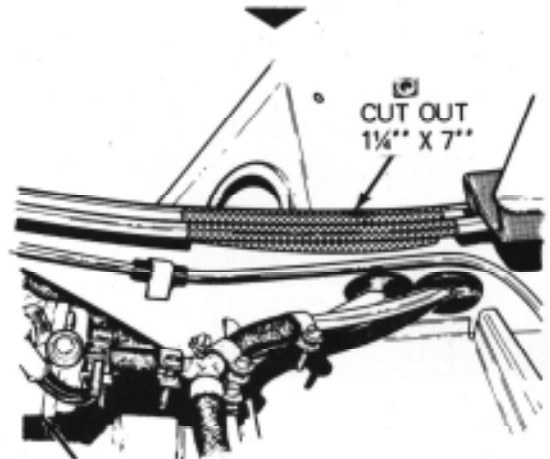

FUEL PUMP

## D. Drilling Holes

- 1— Drill one  $\frac{3}{8}$ \" data-bbox="603 453 943 481"/>

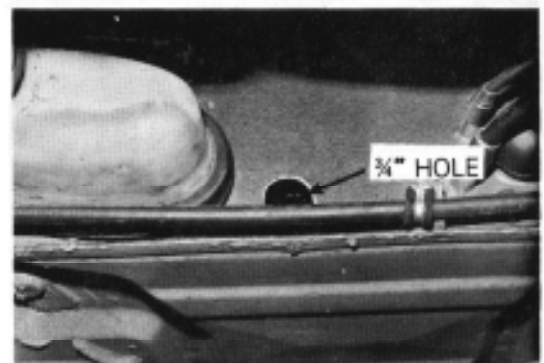

# A/C INSTALLATION PORSCHE 914/4

- 2- Drill one  $\frac{3}{8}$ " hole to the left of the starter motor.  
*(For Red wire to starter solenoid)*

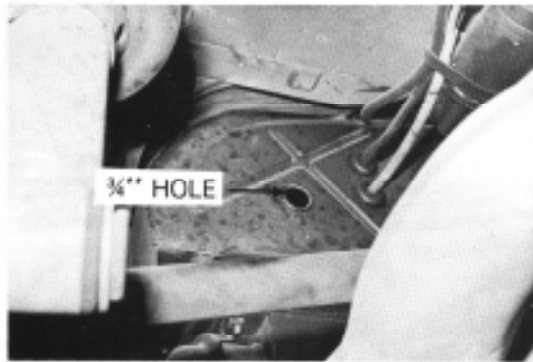

- 3- Using a  $\frac{1}{4}$ " knock-out punch, enlarge the holes in the gussets beneath the right door. Drill a  $\frac{1}{4}$ " hole beneath each hole enlarged.

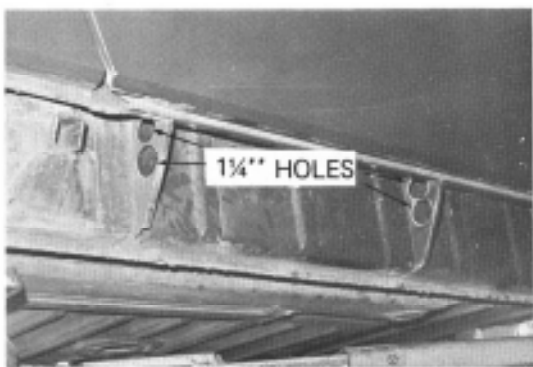

- 4- Drill two  $\frac{1}{4}$ " holes in the box section beneath the right door.

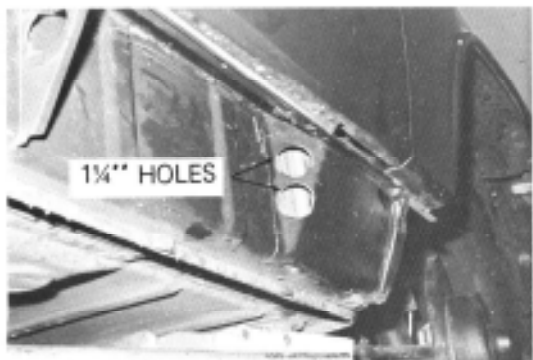

- 5- From the other side, drill two more  $\frac{1}{4}$ " holes in the same box section.

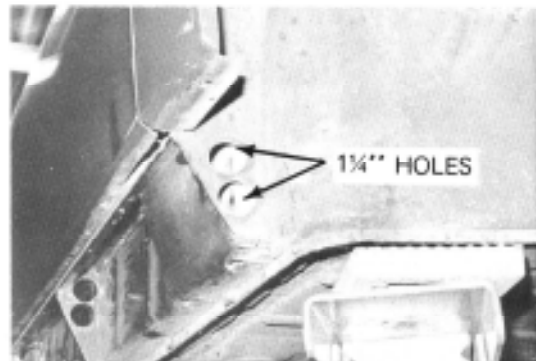

- 6- Drill two  $\frac{1}{4}$ " holes and one  $\frac{3}{8}$ " hole in the right front wheel well approximately 17" up from the lower edge of the inner fender panel.

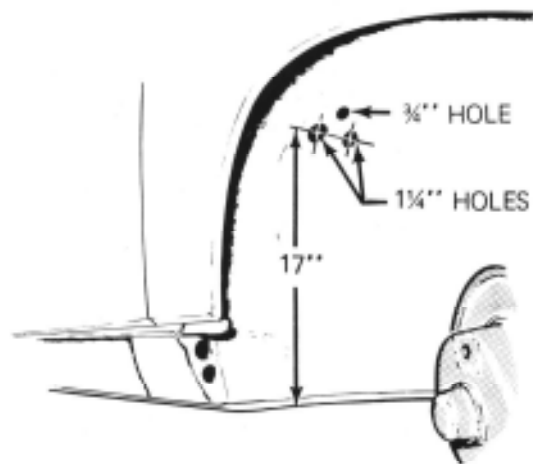

- 7- Using the template ZPW214745, drill one  $\frac{3}{8}$ " and two  $\frac{1}{4}$ " holes into the passenger compartment.

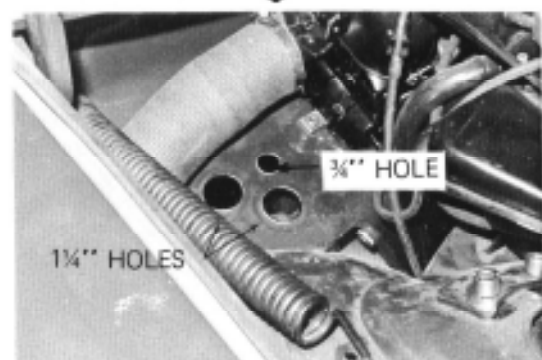

# A/C INSTALLATION PORSCHE 914/4

- 8— Using the template ZPW214744, drill one  $\frac{3}{4}$ " and two  $1\frac{1}{4}$ " holes in the right side of the front luggage compartment.

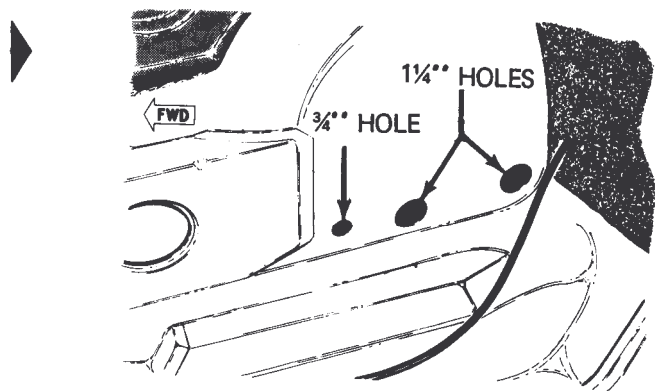

- 9— Using the dimensions given, cut out the spare tire well for condenser placement. Note that the cut across is made between two original rubber plugs.

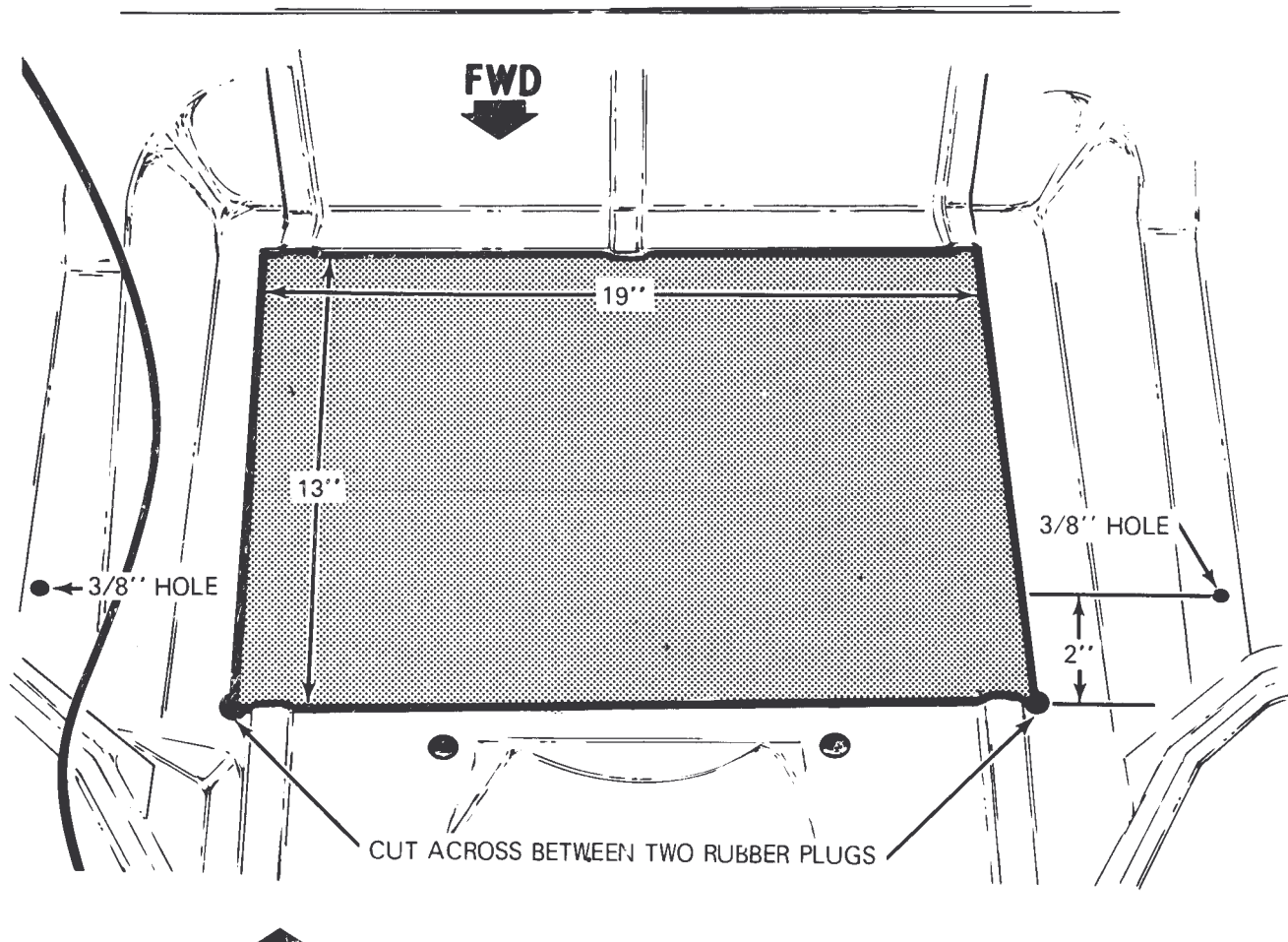

- 10— Place the condenser bracket over the cut-out just made and 2" to the rear of the front edge of the cut-out. Using the bracket as a template, drill two  $\frac{3}{8}$ " holes.



# A/C INSTALLATION PORSCHE 914/4

---

11-Drill two 1/4" holes in front of the battery location.

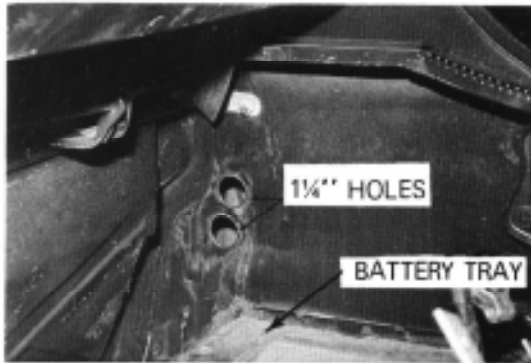

# A/C INSTALLATION PORSCHE 914/4

## ENGINE COMPARTMENT

THE DRIVE PULLEY, COMPRESSOR BRACKETS, AND COMPRESSOR WILL NOW BE INSTALLED IN THE ENGINE COMPARTMENT.

### A. Installing Drive Pulley

- 1— Insert one end of the air conditioner belt from the right side of the air intake housing to reach a point past the crankshaft.
- 2— Place the drive pulley against the crankshaft with the side painted RED towards the crankshaft. The dowel pin on the crankshaft should be through the locator hole on the drive pulley.
- 3— Place the impeller over the drive pulley so that the dowel pin aligns with the hole in the impeller. Replace the three impeller mounting bolts and washers and torque to 14 ft. lbs. (2Mk/g).

**Note:**

Make sure that the air conditioner belt is pulled over to the right and stays in the drive pulley groove while installing the impeller.

- 2— The idler bracket will now be installed where the three nuts were removed beneath the oil filter base. Install the short, threaded spacer on the center stud and the longer, threaded spacer on the lower stud.

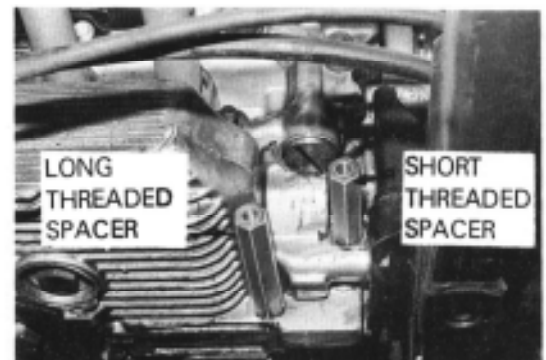

### B. Installing Compressor Brackets

- 1— Install the rubber plug from the kit in the hole where the original air hose stub was removed on the right side of the air intake housing.

# A/C INSTALLATION PORSCHE 914/4

- 3— Place the short tubular spacer on the rear stud. Put the bracket in place and secure with long, shouldered 8mm nut and starwasher. Secure at the threaded spacer with 8mm bolts and lockwashers. Tighten the bracket at this time.

**Note:**

Be sure belt is over idler bearing.



- 4— Install the short, threaded ends of the 8mm studs in the four holes on the right side of the air intake housing.

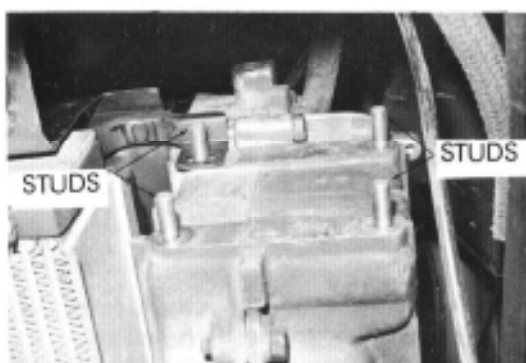

- 5— Install the compressor main mount on these four studs with the hinge arms pointing upwards. Secure with dishwashers, lockwashers, and 8mm nuts. Two of the dishwashers are cut so as not to contact the hinge arm on the bracket. This is so metal will not touch metal and the purpose of the rubber bushings is defeated.

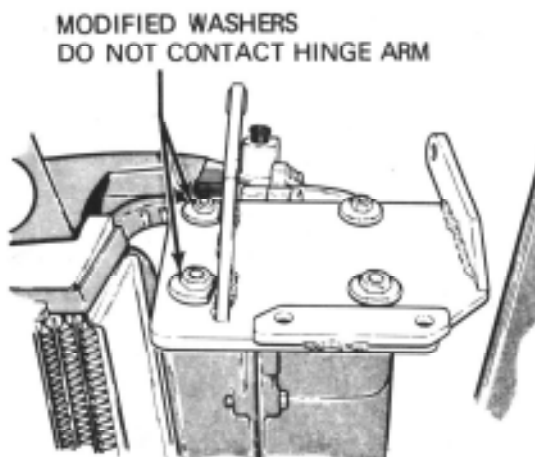

# A/C INSTALLATION PORSCHE 914/4

---

## C. Installing Compressor

- 1- Assemble service valves to respective ports on compressor cylinder head. Do not tighten at this time. Mount the clutch holding coil and pulley on the compressor. The holding coil lead wire should be pointed towards the cylinder head of the compressor. Do not tighten the clutch pulley at this time.

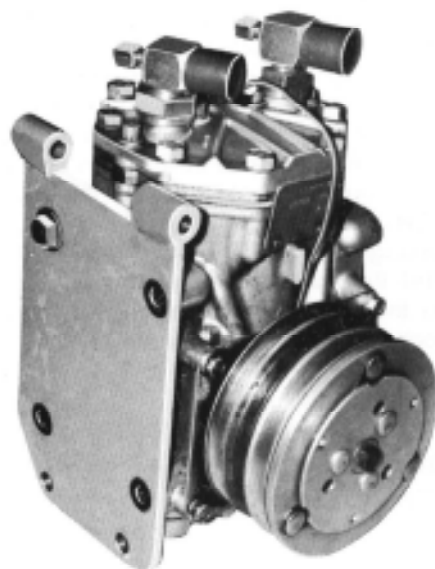

- 2- Secure the compressor mounting plate to the left side of the compressor (viewed from compressor front) with one 3/8 x 3/4" bolt and lockwasher and three 3/8" countersunk allenhead bolts.

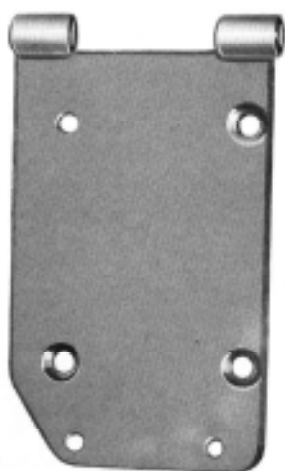

# A/C INSTALLATION PORSCHE 914/4

3—The compressor assembly should now be lifted up into the area alongside the compressor main mount with the clutch to the rear. The front hinge pivot on the mount plate attached to the compressor should be aligned with the hole on the front arm of the compressor main mount. The rear hinge pivot should be aligned with the second hole down on the rear arm of the compressor main mount. From the rear, insert a  $3/8 \times 6''$  bolt through the ground strap from the kit and through both hinge pivots. Secure at the front hinge pivot with a nut and lockwasher. Do not tighten at this time.

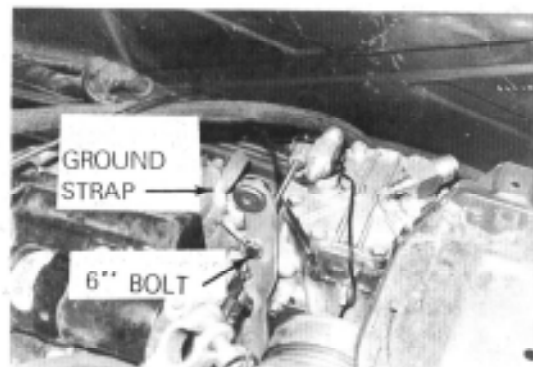

4—Secure the other end of the ground strap with the original screw as shown.



5—Using the short spacer on the backside of the compressor main mount arm, secure the compressor brace with a  $5/16 \times 2\frac{1}{2}''$  bolt, nut and flatwasher. Using a  $3/8 \times 1\frac{1}{2}''$  bolt, nut, and lockwasher, secure the other end of the brace to the vacant hole in the engine case. Tighten this bracket now.

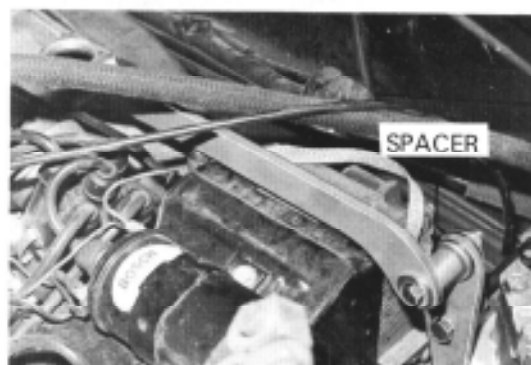

# A/C INSTALLATION PORSCHE 914 /4

6- Reinstall alternator belt and resecure alternator.

7- Place the air conditioner belt on the outside clutch groove. At the bottom between the main compressor mount and the compressor mount plate, insert two 5/16 x 2" bolts, lockwashers and flatwashers through a 1/4" thick shim and the brackets. Insert thinner shims until proper belt tension is achieved. Insert remaining shims under both heads. Tighten both bottom bolts and then tighten the long hinge bolt at the pivots.

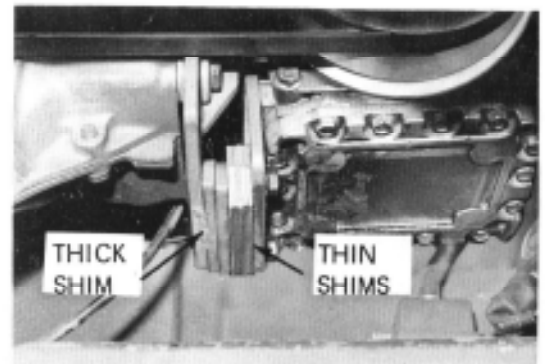

8- Reinstall oil filter.

9- Reinstall fresh air heater pipes and hose.

10- Bend heater control lever down to clear compressor.

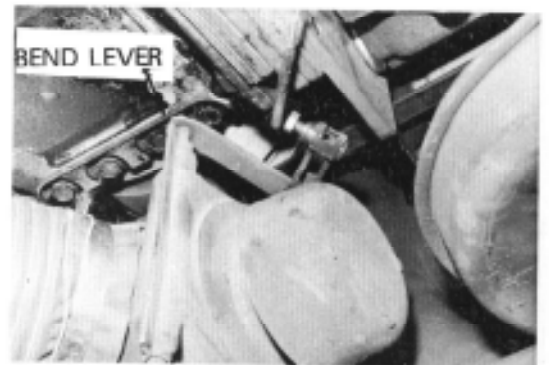

11- Modify the sheet metal panel which was removed and reinstall.

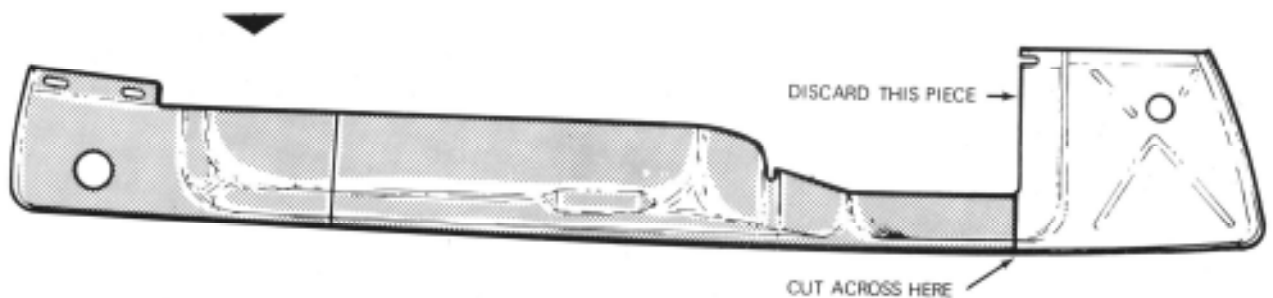

12- Using the two brackets from the kit and the original screws, relocate the fuel injection control box on the right forward side of the firewall.

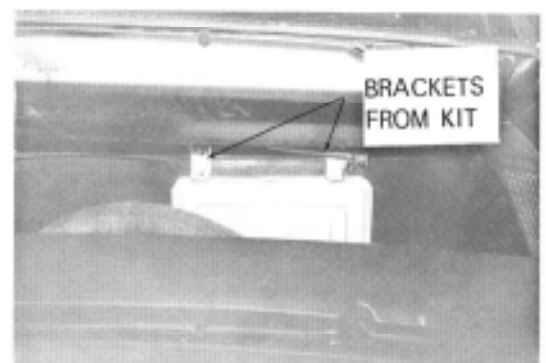

# A/C INSTALLATION PORSCHE 914/4

---

- 13—Route throttle control cable to front of compressor and resecure in original position.
- 14—Reinstall air cleaner.
- 15—Install replacement timing access plug and connect hose.
- 16—Reconnect air hoses in engine compartment.

# A/C INSTALLATION PORSCHE 914/4

## HOSES

HOSES IN THIS KIT COME IN THREE DIAMETER SIZES: NO. 6 (SMALLEST), NO. 8 (MIDDLE SIZE), AND NO. 10 (LARGEST). THEY WILL BE REFERRED TO BY THIS NUMBER.

1—Route the straight ends of the No. 10 suction hose and No. 8 discharge hose forward over the jack adapter. The No. 10 hose should be routed through the upper 1/4" holes in the gussets and box section beneath the right door.

See picture  
on 8-1

2—The No. 8 discharge hose should be routed in the lower 1/4" holes in the gussets and box section. Route both hoses into engine compartment. Check that there is length of hoses to reach compressor before installing grommets and then install grommets. Grommets that are used in the gussets for both hoses are split to ease installation; however, grommets in other locations should not be split. Continue to route the No. 8 hose behind the front shock and with a grommet installed on the hose, pass it through the rear 1/4" hole in the lower part of the spare tire well.

3— With a grommet installed, route the No. 10 hose through the outside 1/4" hole in the upper rear portion of the wheel well.

4— With the grommet installed on the hose, route the 45° end of the long No. 6 hose through the 1/4" hole next to the suction hose.

5— With grommet installed on the hose, route one end of the short No. 6 hose through the front 1/4" hole in lower part of the wheel well.

6— Using the 3/4" hole previously drilled as a reference, locate the receiver-drier and install with clamps.

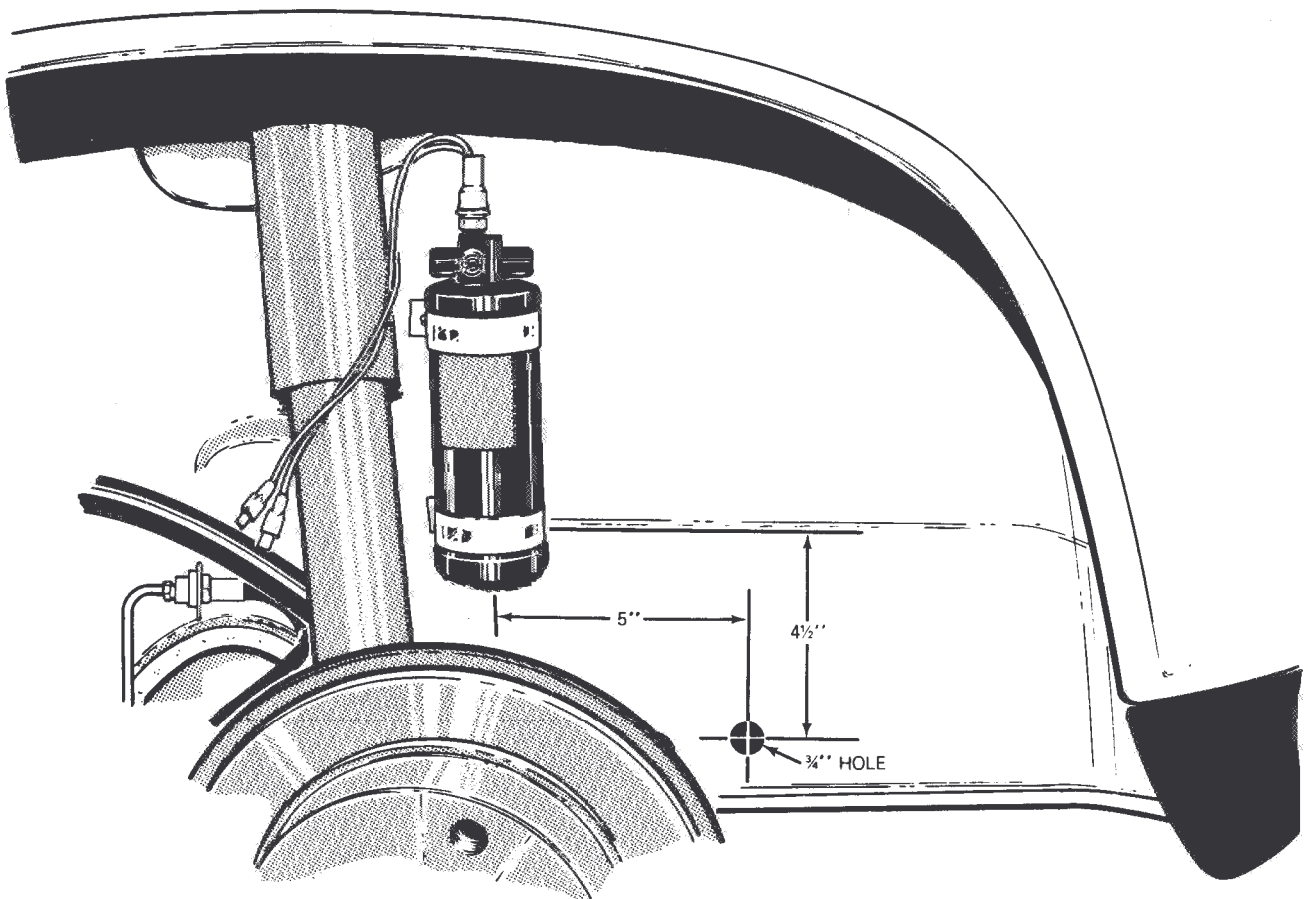



# A/C INSTALLATION PORSCHE 914/4

---

7- Connect hoses to service valves.  
Tighten service valves.

8- With grommets installed, route the suction and liquid hoses through the two 1¼" holes into the passenger compartment.

# A/C INSTALLATION PORSCHE 914/4

## CONDENSER

**THE CONDENSER ASSEMBLY WILL NOW BE INSTALLED IN THE AREA OF THE SPARE TIRE WELL. LATER THE SPARE TIRE WILL BE REMOUNTED ATOP THE CONDENSER ASSEMBLY.**

- 1—Place the polyfoam sealing strip provided around the edge of cut-out made in the floor.
- 2—Place the condenser over the cut-out with the scoop on the condenser pointing forward and the hose connections to the right.
- 3—Place the bracket over the condenser aligning it with the 3/8" holes previously made and secure with 1/4 x 1" bolts and nuts. Bolts should be inserted from below.
- 4—Connect the No. 8 and No. 6 hoses to the condenser.
- 5—Drill No. 30 hole in luggage compartment floor and secure condenser motor ground wire with a No. 8 screw. When grounding wire scrape the area clear of paint.

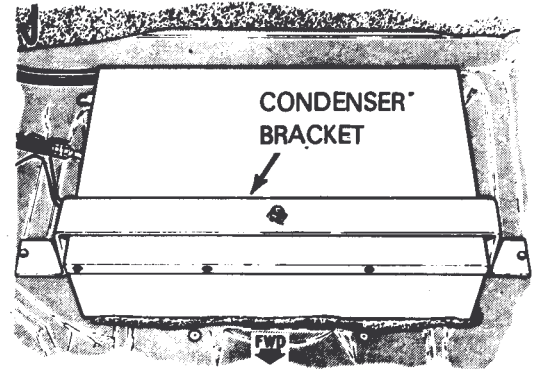

# A/C INSTALLATION PORSCHE 914/4

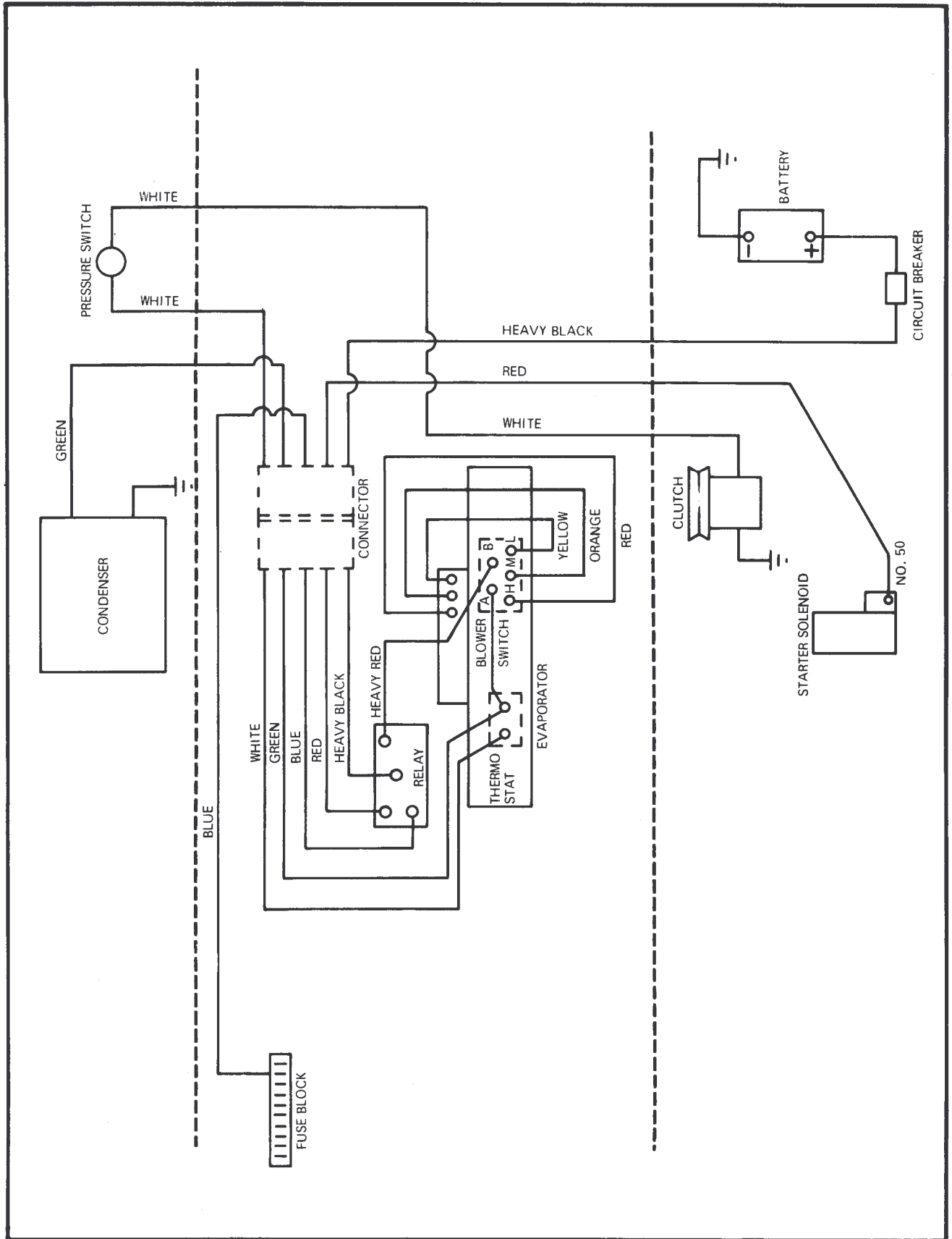

# A/C INSTALLATION PORSCHE 914/4

## WIRING

THE WIRING WILL NOW BE ROUTED TO ALL OF ITS CONNECTIONS. START IN THE PASSENGER COMPARTMENT AND ROUTE FORWARD INTO THE LUGGAGE COMPARTMENT. THEN ROUTE REARWARD TOWARDS THE ENGINE COMPARTMENT.

1- Pass the branch containing the GREEN and WHITE wires from the inside of the car through the  $\frac{3}{4}$ " hole under the dashboard and into the luggage compartment. Route down through the other  $\frac{3}{4}$ " hole into the right wheel well and install grommets. Follow No. 8 hose and pass GREEN wire into luggage compartment through forward  $\frac{3}{4}$ " hole. Install grommet and connect GREEN wire to condenser motor wire. Connect WHITE wires to the pressure switch wires.

2- Route the remainder of the wiring over and down the center of the vertical panel, behind corner of the pedal cluster panel, and into the tunnel with the original wiring.

3- Route the wiring harness down the tunnel with the original wiring, securing it with wiring clips already in place. Remove circuit breaker and route wire through the  $\frac{3}{4}$ " hole into the engine compartment and install a grommet.

4- Route the BLUE wire to the left over the dashboard bracket and under the steering shaft. Connect to the ignition control fuse on the fuse panel. Clamp the wire with a strap clamp to the underdash to clear the movement of the steering shaft.

5- Place the battery back in the car. Reinstall circuit breaker and connect the wiring lead with the circuit breaker to the battery. Clamp the wire to the fuel injection control box bracket with a strap clamp to keep the circuit-breaker in the air flow area.

6- Connect the WHITE wire to the clutch lead wire.

7- Route the RED wire through the  $\frac{3}{4}$ " hole previously drilled next to the starter. Install grommet. Connect the RED wire to the No. 50 terminal of the starter solenoid.

8- Clamp wires in engine compartment in front of impeller into original body wiring clamps.

See 8-1

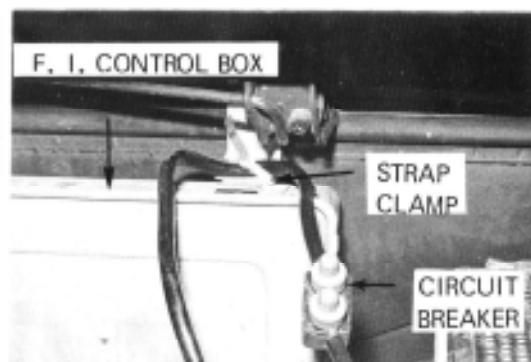

# A/C INSTALLATION PORSCHE 914/4

## EVAPORATOR

**THE EVAPORATOR WILL NOW BE INSTALLED UNDER THE DASHBOARD TO THE RIGHT OF STEERING COLUMN.**

1—Drill two ½" holes in the forward wall for the drain tubes.

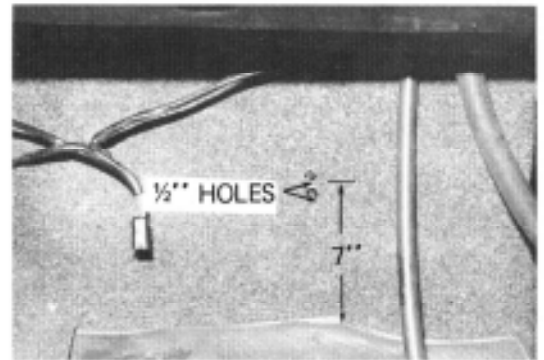

2—Remove the 6mm screw from the dashboard bracket. This screw is located immediately forward of where the trip odometer cable meets the dashboard.

3—Loosen the three screws securing the lower edge of the dashboard padding.

4—With hanger brackets loosely installed on sides of evaporator with ¼" bolts, lift evaporator to underside of dashboard with extreme left bracket located to original dashboard bracket hole and with flange bracket on top of evaporator bezel between the dashboard and padding. The hanger brackets on the side evaporator should be positioned over the lower edge of dashboard at the same time.

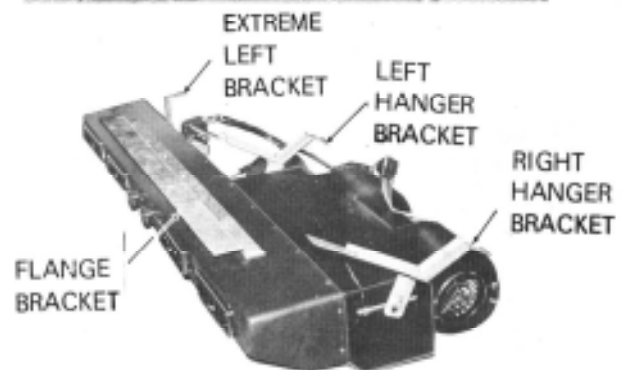

5—With the evaporator supported in this position mark through the holes in the hanger brackets.

6—Lower the evaporator and drill two No. 30 holes in the underdash where marked.



7—Remove two hanger brackets from evaporator and install to underdash where drilled.

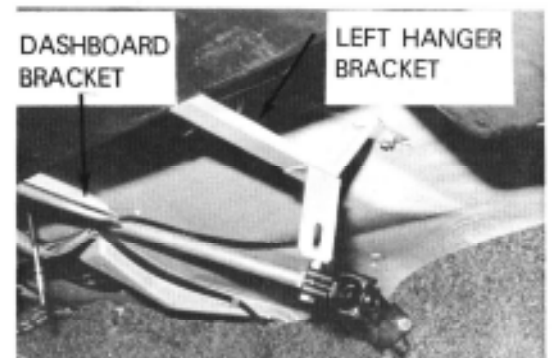

# A/C INSTALLATION PORSCHE 914/4

---

- 8- With the evaporator on the floor of the car, connect the No. 10 hose to the suction pipe of the evaporator coil and wrap with sealing compound.
- 9- Attach the No. 6 hose to the expansion valve.
- 10- Plug the evaporator wiring harness to the body wiring harness.

- 11- Lift evaporator back into position and secure hanger brackets to evaporator.



- 12- Secure extreme left bracket with original 6mm screw to original dashboard bracket hole.
- 13- Resecure three dashboard padding screws.
- 14- Insert odometer cable loosened previously through lower hole in extreme left bracket and resecure using the original nut and washer and conewasher from kit.

- 15- Ground evaporator motor wire to foot-rest securing strap on right side.



- 16- Connect drain tubes to evaporator and insert through forward wall.

# A/C INSTALLATION PORSCHE 914/4

## COMPLETION

- 1- Connect battery ground.
- 2- Tighten clutch center bolt to 15-20 ft. lbs. with current on.
- 3- Connect hoses to receiver-drier.
- 4- Evacuate system.
- 5- Clamp hoses and wiring in right front wheel well.

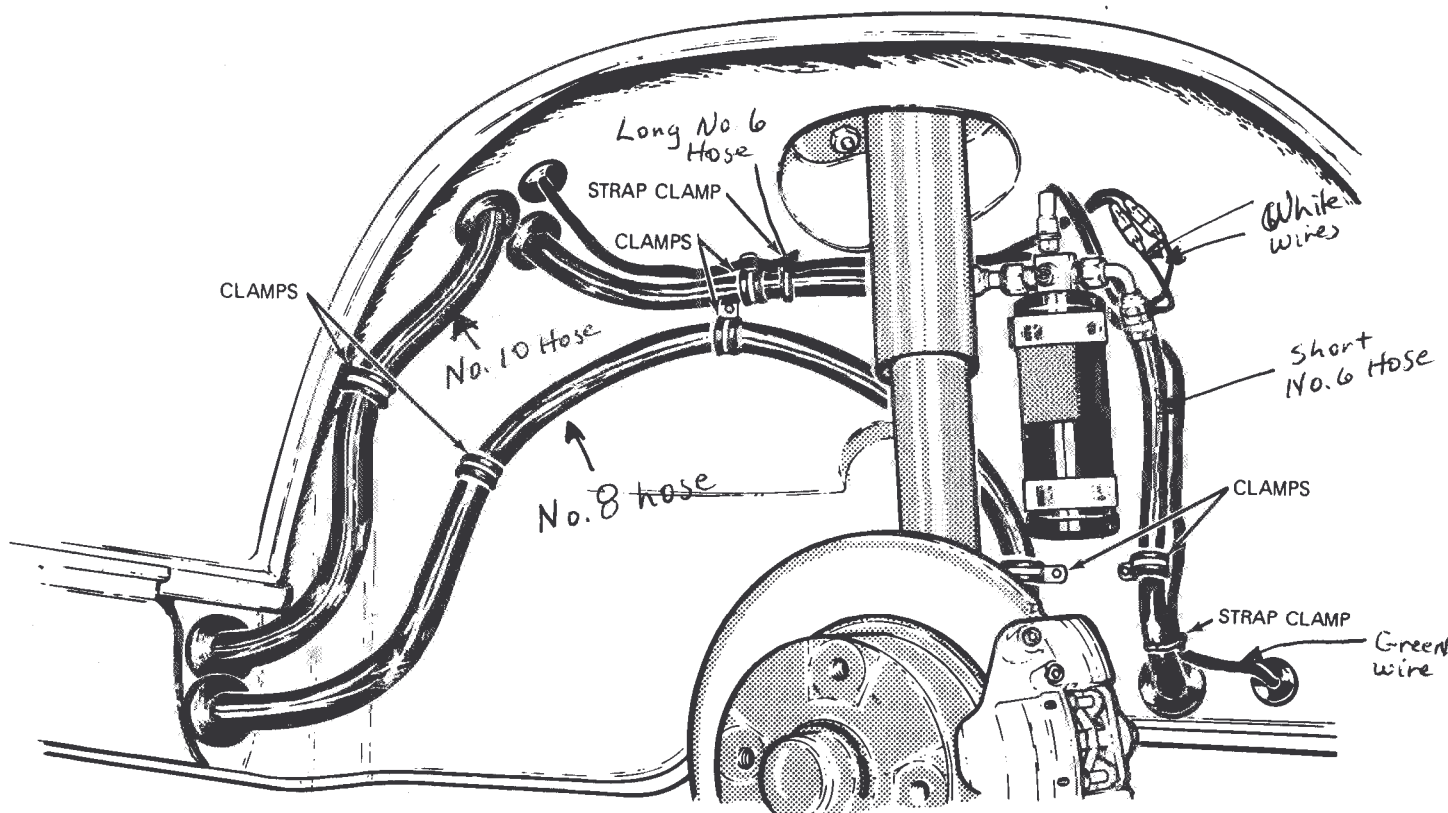

- 6- Reinstall spare tire using spacer under bolt head. Do not overtighten.
- 7- Modify spare tire cover. Resecure carpet on cover with three No. 6 x 3/8" screws and washers. Reinstall cover.

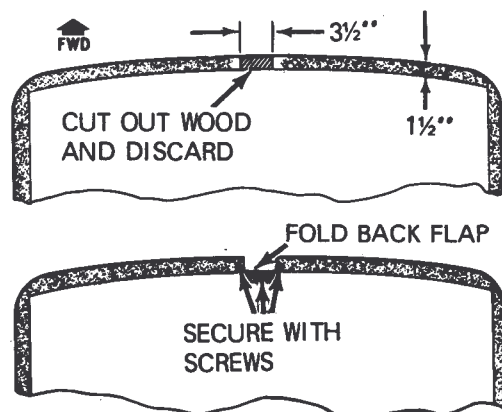

# A/C INSTALLATION PORSCHE 914/4

---

- 10— Reinstall washer bottle.
- 11— Reinstall inspection plates on tunnel.
- 12— Reinstall panel behind pedal cluster.
- 13— Reinstall console.
- 14— Reinstall floor mats.
- 15— Reinstall rocker cover.
- 16— Resecure step plate with No. 8 x ¼" screws in place of rivets.
- 17— After evacuation is complete, charge system.
- 18— Reinstall right front wheel.