

# GENERAC

*Portable Generator*

*Power Transfer System with Load Manager™*

*Owner's Manual*

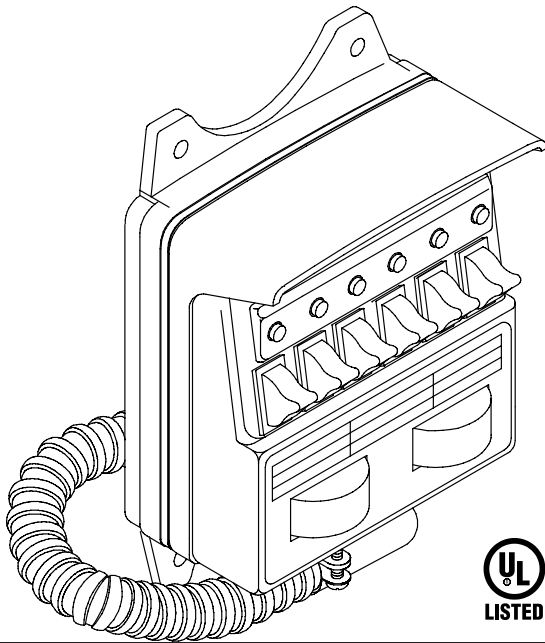

**Problems?  
Questions?**  
Before taking your system  
back to the store,  
call the generator  
helpline at  
**1-800-270-1408**  
**M-F 8-5 CT**

## CONTENTS:

Installation Instructions -----Page 1 through 12  
Owner's Operating Instructions -----Page 13 through 16

## IMPORTANT

This product must be installed in compliance with local residential wiring and electrical codes by a licensed electrician or qualified professional. Generac Portable Products is not responsible for damaged equipment, accidents, or personal injury caused by incorrect installation.

Read this Safety Manual and Instructions BEFORE operating Power Transfer System.

## DESCRIPTION

The Model 1276 Power Transfer System safely connects up to six vital or essential household loads, such as the furnace fan, freezer, refrigerator, water well pump, sump pump, or lights to either the utility power or a portable generator. In the event of a utility power failure, the homeowner can safely select individual essential devices to be powered by an outdoor portable generator. The power transfer system will not permit connection to both utility and generator power at the same time.

The Model 1276 Power Transfer System is easy for a licensed electrician or qualified professional to install, safe for a homeowner to operate, and will work with 240 Volt AC generators factory equipped with a NEMA type L14-20R or L14-30R receptacle.

**NOTE:** The maximum load allowed through the Load Manager™ switch is 7200 watts, 30 Amps at 240 VAC / 60 Amps at 120 VAC.

Visit our Generac website: [www.generac-portables.com](http://www.generac-portables.com)

Model No. 1276-1 Power Transfer System Manual No. B4628 (Revision 3, 1/28/2000)

This manual contains Important warnings and information. READ AND RETAIN FOR REFERENCE.



**!** Per National Electric Code, connection of a generator to any electrical circuit normally powered by an electric utility must be by means of approved transfer switch equipment so as to isolate the electrical circuit from the utility distribution system when the generator is operating. Failure to isolate the electrical circuits by such means may result in injury or death to utility power workers due to backfeed of electrical energy.

**!** The Load Manager™ switch is suitable for use in accordance with Article 702 of the National Electric Code, ANSI/NFPA 70. This switch is suitable for use on a circuit capable of delivering not more than 1000A RMS, symmetrical current, 125/250V, when installed on the load side of appropriate branch circuit. For indoor use only. The connection box is a NEMA type 3R, intended for outdoor use.

## GENERATOR COMPATIBILITY



Only use a generator that is factory-equipped with a NEMA L14-20R or NEMA L14-30R receptacle, shown in Figures 18 and 19.

NEVER use a generator equipped with a 3-prong 240V receptacle because damage may occur in connected appliances.

## UNPACKING

Remove the Power Transfer System components shown in Figure 1 from the shipping carton.

The Load Manager™ switch is completely prewired and ready for installation. Inspect the switch and its attached components for any shipping damage.

The connection box is supplied ready to be wired. Inspect it, the connection cord set, and the connecting plugs for any damage.

The installer will select and connect the appropriate connection cord plug, as described in the Installation Procedure, step 21.

### Items Not Shipped with Power Transfer System:

The following items, required for system installation, are not included and must be provided by the installer:

1. Tools required for installation
2. Anchors and screws to mount the power transfer system components and conduit.
3. Junction box(s), conduit, fittings, wire nuts, and insulated copper wire for connecting the Load Manager™ switch to the outside connection box.

## SPECIFICATIONS

Model Number.....	1276
Maximum Circuits.....	6
Maximum Load/Circuit from Generator.....	15 Amps
Maximum Load/Circuit from Load Center.....	20 Amps
Maximum Watts.....	7200
Connecting Cord Length.....	10 ft.
Connection Box power inlet connector ...	NEMA L14-30

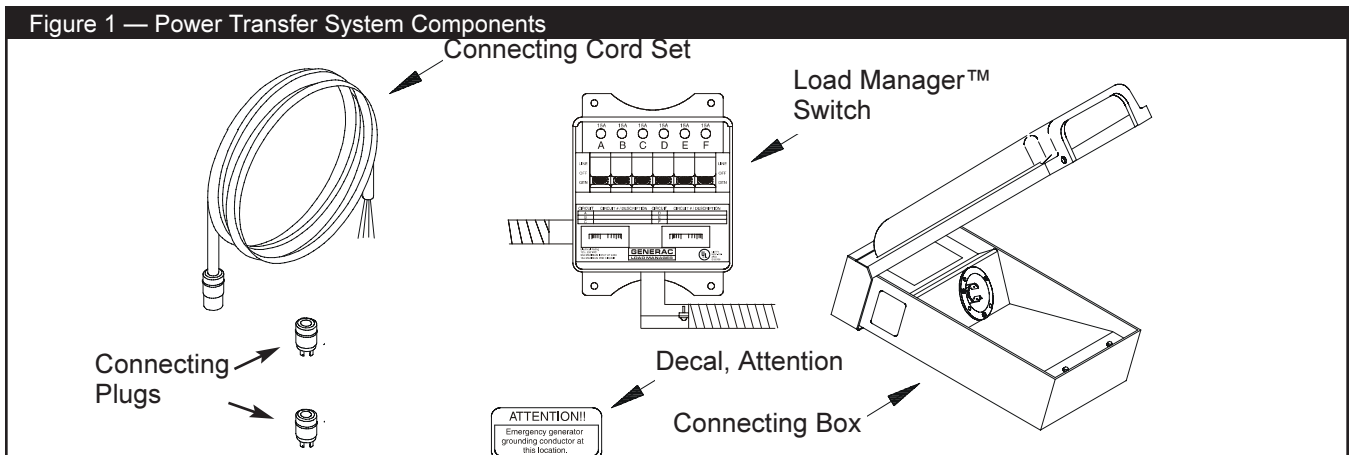

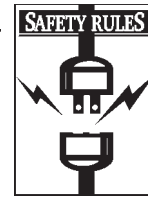

## GENERAL SAFETY INFORMATION

1. **A licensed electrician or qualified professional (referred to herein as “installer”) must install the power transfer system per local code.**
2. During installation, the installer is required to remove the cover from the building power distribution panel (referred to herein as a ‘load center’.) To reduce the risk of electrical shock, the Main circuit breaker must be turned OFF while the load center cover is removed.
3. **DO NOT OVERLOAD THE GENERATOR.** Overloading a generator in excess of its rated wattage capacity will trip generator circuit breakers.
4. Contrary to generator owner’s manual, always plug the connecting cord set into the connection box and generator BEFORE starting the generator. Always shut the generator down before detaching the cord set.
5. **PORTABLE GENERATORS ATTACHED TO THIS POWER TRANSFER SYSTEM MUST BE OPERATED OUTSIDE**, in accordance with warnings and instructions found in the generator’s Owner’s Manual.

## PLAN THE INSTALLATION

The installer and the homeowner decide which circuits are to be powered by the generator during a utility power outage:

- The plan should ensure that no single circuit load exceeds 15 Amps.
- The plan should also identify circuits that exceed the 15 Amp maximum.
- During generator operation, the homeowner should use only necessary household items and to alternate use of larger loads, such as water pump, electric skillet, or furnace fan. The installer will instruct the homeowner in appropriate load management techniques.

Three methods of determining loads are given.

### Measure Actual Loads

The installer uses a clamp-on ammeter to measure each of the actual desired loads to ensure each total circuit draws less than 15 Amps.

### Sum Loads from Data Plates

The installer inspects each desired device, notes current consumption found on labels on each appliance, then adds all loads on each circuit:

- The rated current of appliances and motors can usually be found on a data plate or decal affixed to the device.
- The rated wattage of lights can be taken from light bulbs.
- Some electric motors, such as induction types, require two or three times more power for starting than for running. This surge of power lasts for only a few seconds when starting such motors. Be sure to allow for this high starting load.

### Estimate Loads

The third method estimates total circuit loads based on information given in Figure 2.

Figure 2 — Load Reference Guide	
APPLIANCE	LOAD DRAW
Air Conditioner (12,000 BTU)	~(1700W) 7A@240V
Coffee Maker	~(1000W) 8.4A@120V
*Electric Range (one element)	~(1500W) 6.3A@240V
Electric Blanket	~(1500W) 12.5A@120V
Electric Skillet	~(1250W) 10.5A@120V
*Freezer	~(500W) 4.2A@120V
*Furnace Fan (1/3 HP)	~(1200W) 10A@120V
*Jet Pump	~(800W) 3.4A@240V
Light Bulb	~(100W) 0.9A@120V
Microwave Oven	~(700W) 5.9A@120V
Oil Burner on Furnace	~(300W) 2.5A@120V
Oil Fired Heater (30,000 BTU)	~(150W) 1.3A@120V
Oil Fired Heater (85,000 BTU)	~(225W) 1.9A@120V
Oil Fired Heater (140,000 BTU)	~(400W) 3.4A@120V
Radio	~(50 to 200W) 0.5 to 1.7A@120V
*Refrigerator	~(600W) 5A@120V
*Submersible Well Pump (1 HP)	~(2000W) 8.4A@240V
Sump Pump	~(600W) 5A@120V
Television	~(200 to 500W) 1.7 to 4.2A@120V

\* Allow 3 times the listed watts for starting these devices.

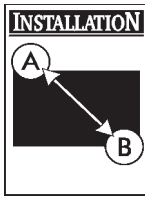

## INSTALLATION PROCEDURE

### Load Manager™ Switch

Before removing the load center cover, plan where to mount the Load Manager™ switch. Hold the Load Manager™ switch about 18 inches from the center of the load center, as shown in Figure 3.

Figure 3 — Planning Switch Location



1. Ensure there is enough room to mount the Load Manager™ switch to properly connect the flex conduit to the load center.
2. Identify an appropriate vacant load center 3/4" knockout.

**⚠ DANGER:** Contact with wires and terminals inside the load center must be avoided as contact may result in dangerous electrical shock. Before removing the load center cover, switch OFF the main circuit breaker serving the load center. Remember that wires on the line side of the main circuit breaker are electrically dangerous.

3. Turn OFF the load center's main circuit breaker, then remove the load center cover.
4. Remove the predetermined knockout. Route all wires extending from the flexible conduit attached to the Load Manager™ switch through the empty hole, as shown in Figure 4. Secure the conduit connector to the load center with the supplied lock nut.
5. Anchor the Load Manager™ switch to the wall at the selected position, as shown in Figure 5.

Figure 4 — Wire Loom from Switch

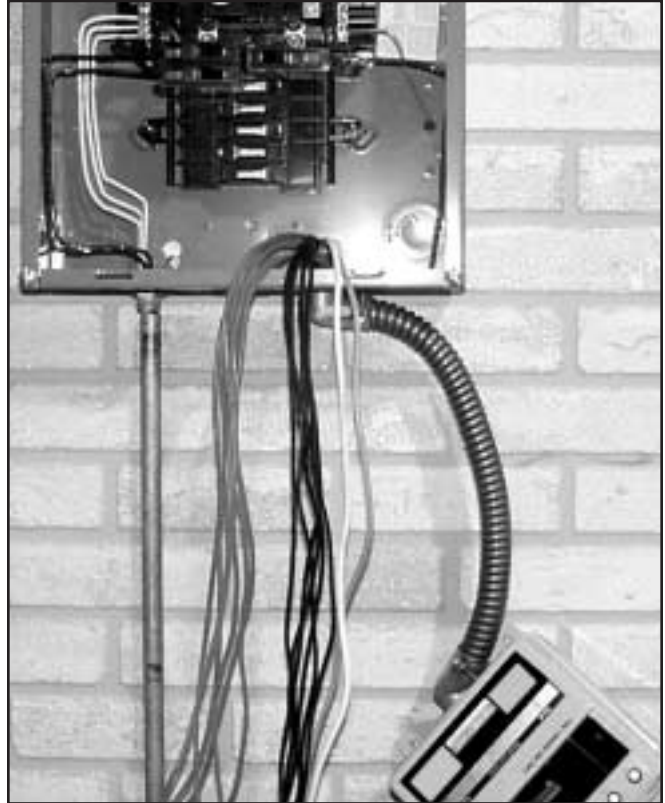
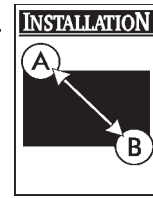
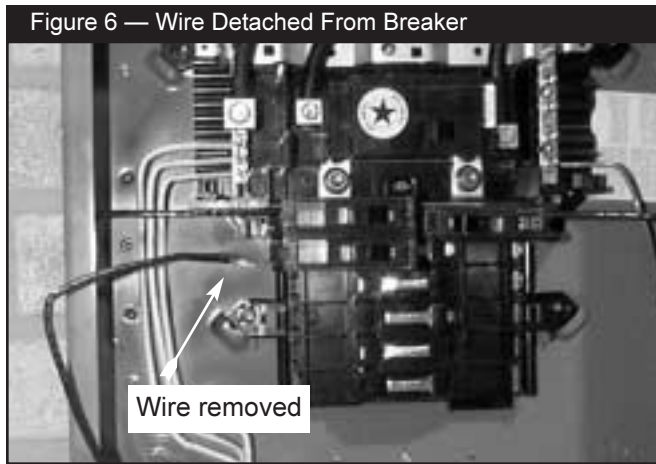

Figure 5 — Anchoring Load Manager™ Switch





6. From the plan, determine the load that is to be connected to Load Manager™ switch circuit “A”. Turn that load center circuit breaker to its “OFF” position. Loosen the screw that retains the wire to this breaker, then detach the wire. Figure 6 shows the selected load wire detached from the circuit breaker.



7. Find the black and red wires marked “A” that come from the Load Manager™ switch. Using good workmanship, route both of these wires near the selected circuit breaker. Trim and strip the red “A” wire and install it properly into the circuit breaker.
8. Trim and strip the black “A” wire to mate with the wire previously detached from the breaker. Secure the wire ends with a wire nut. Neatly dress the wires into the load center, as shown in Figure 7.

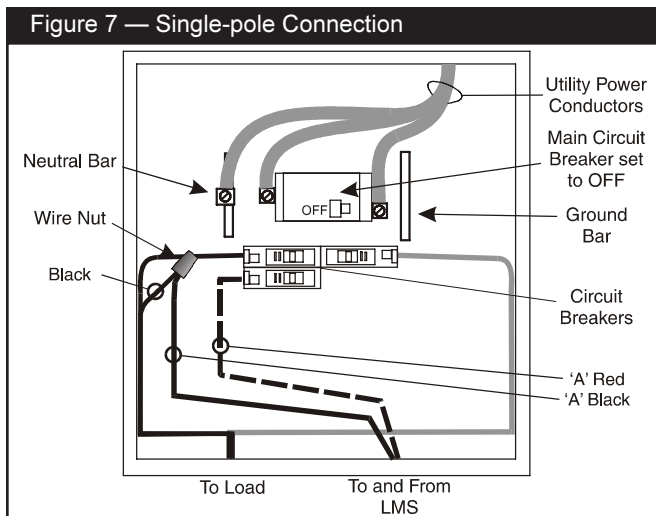

**IMPORTANT:**The installer should never cross the black and red leads from the Load Manager™ switch. Doing so will void the warranty and could cause significant damage to Load Manager™ components and the generator.

**Make Sure:**

- The RED wire from the Load Manager™ switch is **always** connected to the circuit breaker.
- The BLACK wire from the Load Manager™ switch is **always** connected to the wire going to the load.

**! DANGER!** You must connect the Load Manager™ switch wires as described or serious damage to the equipment or yourself may result.

9. Select the load center circuit that will become load management circuit “B”. Repeat Steps 6 through 8 for the red and black wires marked “B” coming from the Load Manager™ switch.
10. If you wish to connect a 240 Volt AC two-pole circuit, such as a well pump, proceed as follows:
  - a. Turn off the two-pole circuit breaker used for the pump circuit and detach the load wires from that breaker.
  - b. Select the four wires marked “C” and “D” coming from the Load Manager™ switch conduit and route them close to the selected circuit breaker(s).
  - c. Repeat Steps 6 through 8 for each pair of red and black wires “C” and “D”.
  - d. A typical two-pole circuit connection is shown in simplified form in Figure 8.

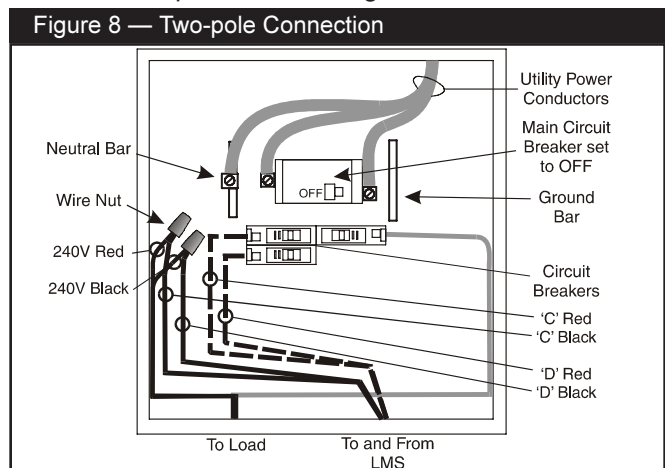



11. If a two-pole circuit is not needed, the two-pole coupled switch can be converted into two single-pole circuits. Simply remove and discard the handle tie connecting load management circuits “C” and “D”, as shown on the right in Figure 9.

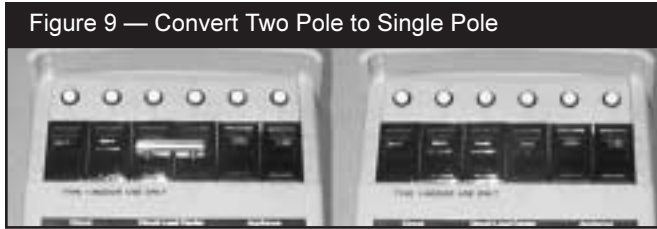

Handle Tie Installed      Handle Tie Removed

12. When steps 6 through 8 have been completed for all desired essential circuits, install the WHITE (neutral) lead coming from the Load Manager™ switch, as follows:
- Find an unused hole in the load center neutral bar.
  - Trim and strip the white wire and install it into the neutral bar.
  - Figure 10 shows a properly-connected WHITE lead.

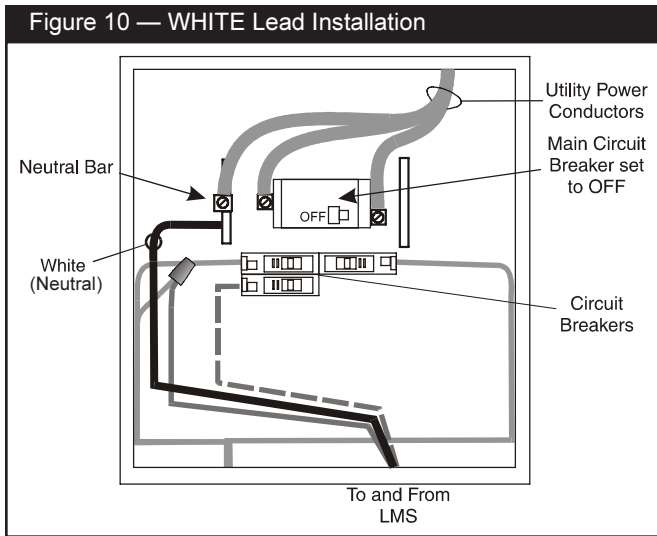

13. Install the GREEN lead coming from the Load Manager™ switch, as follows:
- Find an unused hole in the load center GROUND bar.
  - Trim and strip the green wire and install it into the GROUND bar.
  - Remove protective backing from Attention Decal. Per NEC, affix decal to load center surface closest to the green wire installed in (b.) above.
  - If no ground bar exists, install the GREEN wire into an unused hole in the neutral bar. Affix label as described in (c.).
  - Figure 11 shows a properly-connected GREEN lead.

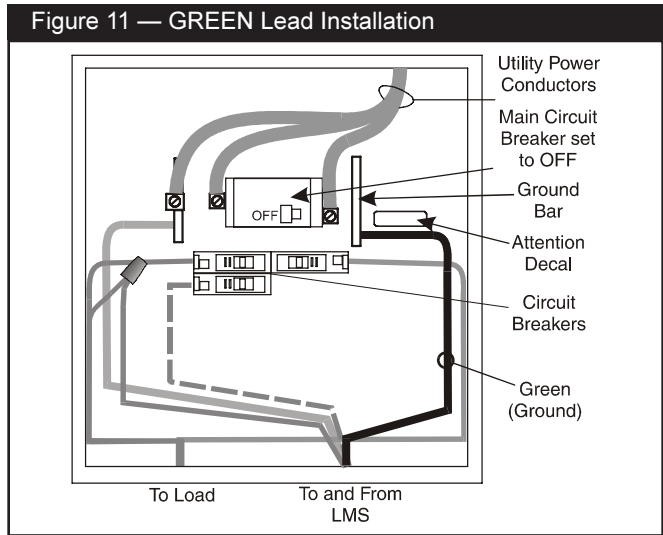

14. Install the load center cover. Set all switches on the Load Manager™ switch to the “LINE” position. Turn ON the load center MAIN breaker. All breakers in the load center connected to Load Manager™ circuits should be switched on. The Load Manager™ switch installation is now complete.

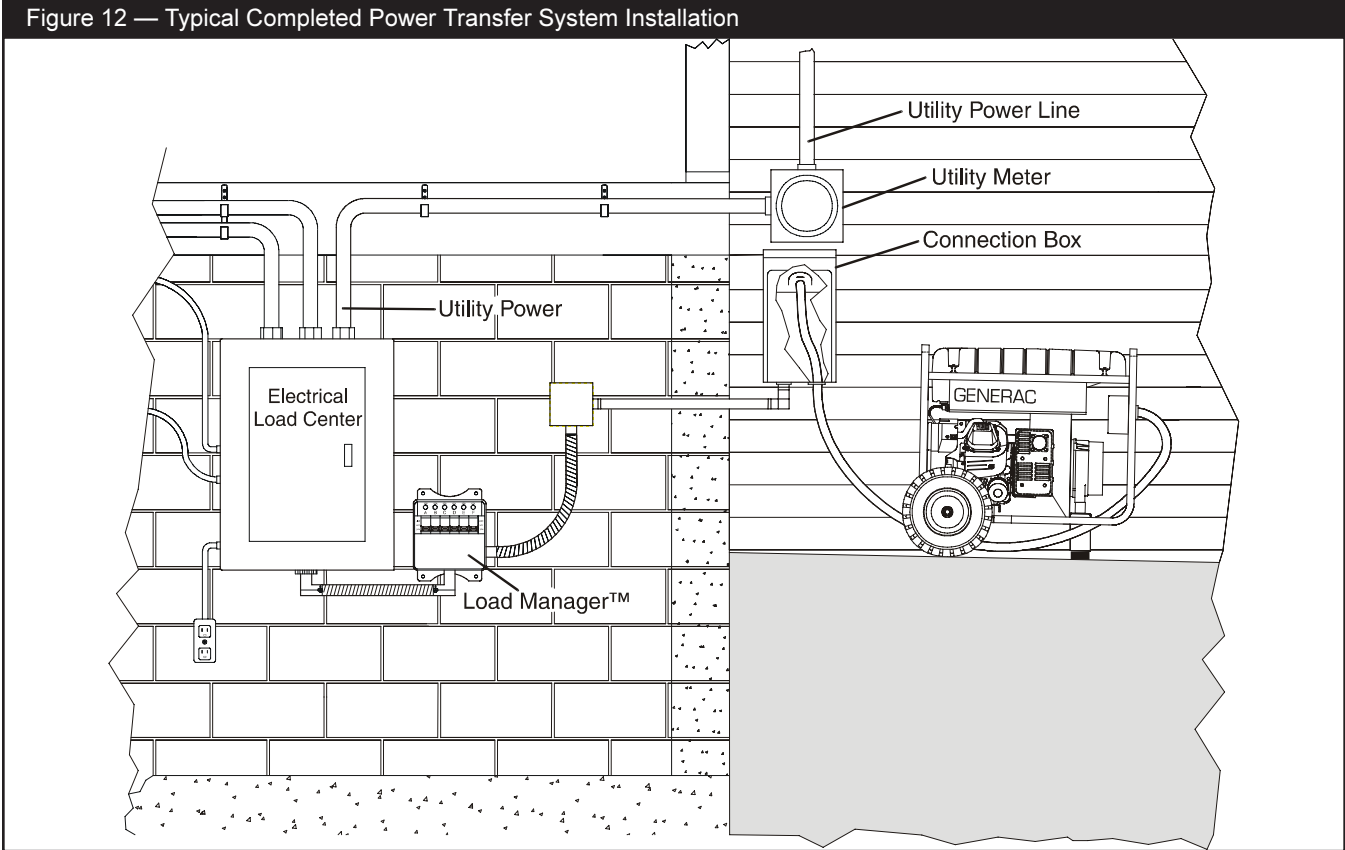
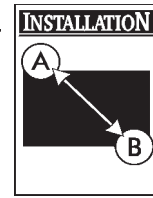

**Connection Box**

The installer should use local codes and the following procedure to install the generator connection box provided with this system.

15. Locate and mount the connection box on an outside wall as close as possible to the load center. However, consider household air intake ducting when when locating generator and connection box. A typical power transfer system complete installation is depicted in Figure 12.
16. As shown in Figure 13, mount a junction box at the appropriate distance from the Load Manager™ switch so that the 1/2" flexible conduit can be connected to it.

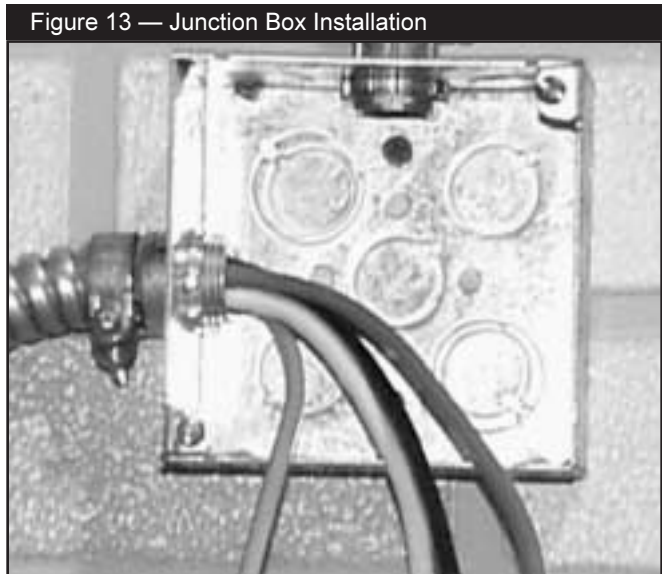

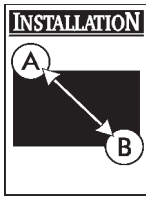

17. Referring to Figure 14, remove the connection box inner panel. Mount the connection box on an outside wall.



18. Run appropriately sized conduit from the junction box to the connection box. Anchor all boxes, conduit, and fittings.

19. Pull four properly-sized insulated wires through the conduit joining the junction box and the connection box. Trim and strip each wire in the junction box. Make secure connections using wire nuts, as shown in Figure 15. Install the junction box cover.

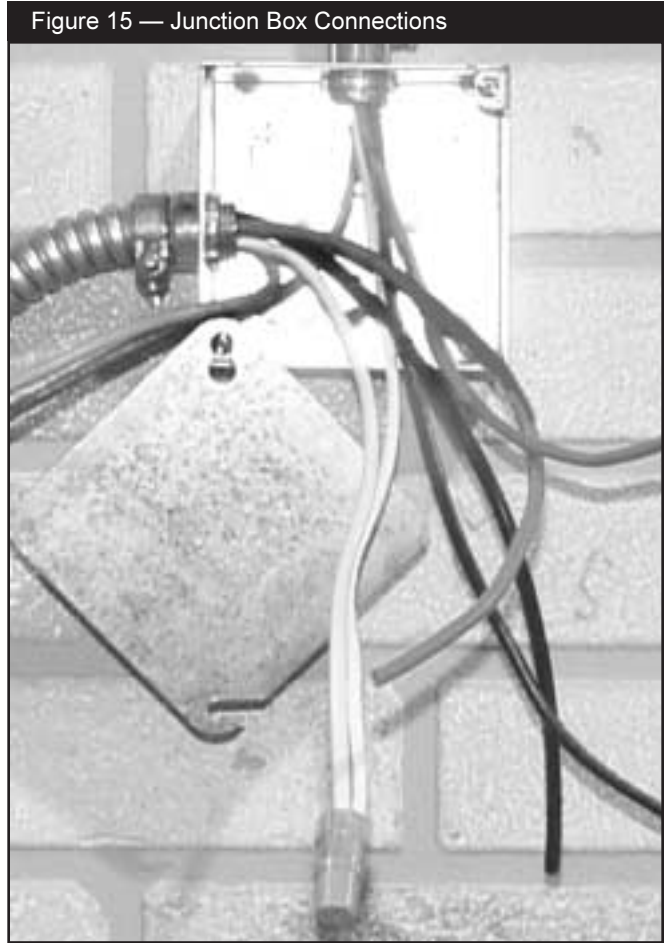



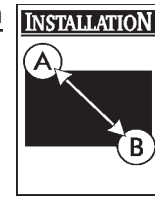

20. As shown in Figure 16, trim, strip, and connect each wire to the appropriate terminal on the locking receptacle on the connection box inner panel. Use the schematic affixed to the inside of the connection box to make proper wire connections. When all connections have been made, install the connection box inner panel.

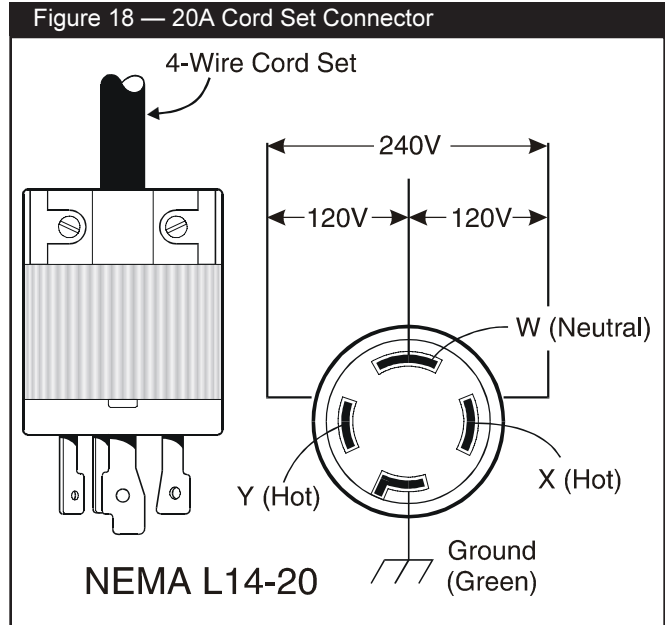

**Connecting Cord Set**

21. From the two 240 Volt connection plugs supplied with the Power Transfer System, select the one that mates to the generator. Referring to the image in Figure 17 and the schematic in Figure 18 or Figure 19 that applies to the connector being used, properly attach the plug to the pigtail end of the connecting cord set.

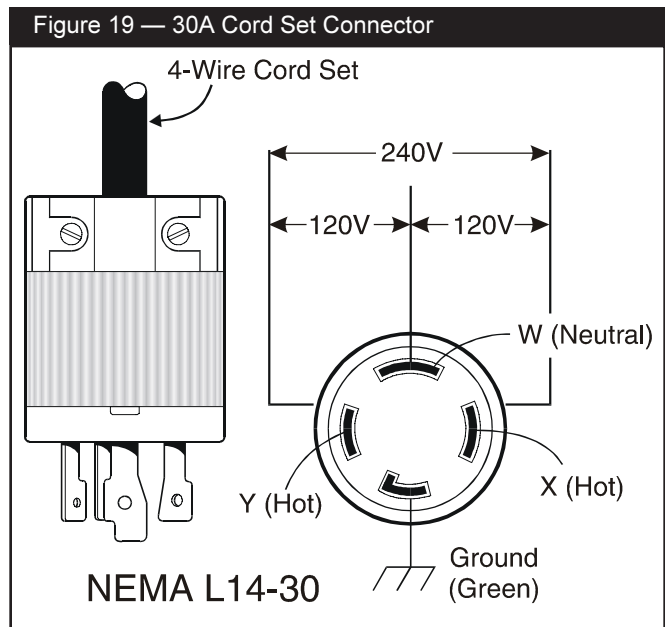
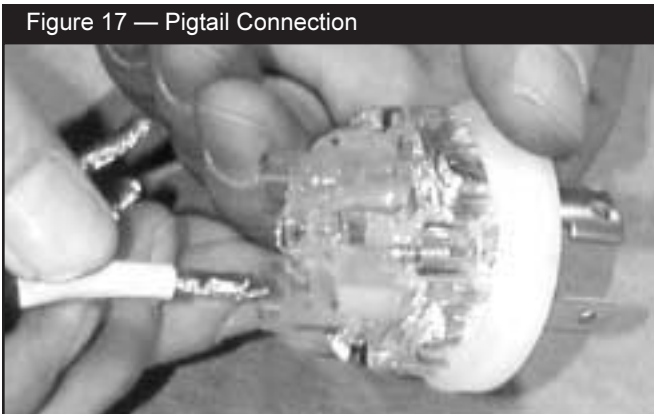

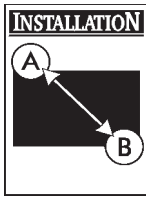

## Identifying Circuits

A label, similar to that depicted in Figure 20, is provided on the Load Manager™ switch cover. The installer should fill-in this information, describing the appliance and the related circuit numbers in the load control center.

This completes the installation of the Generac Power Transfer System. The installer should test the system, as described in the TESTING section, and instruct the homeowner in proper testing techniques.

## Installation Notes

Use the space below to note any special conditions or instructions for load management.

Figure 20 — Circuit Identification Label

CIRCUIT	CIRCUIT # / DESCRIPTION	CIRCUIT	CIRCUIT # / DESCRIPTION
A		D	
B		E	
C		F	

Electrical Rating  
125 / 250 VAC  
30A MAXIMUM INPUT AT 240V  
15A MAXIMUM PER CIRCUIT

**GENERAC**  
**LOAD MANAGER**

LISTED  
MISC. SW.  
4R50  
E182436

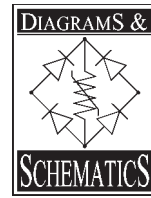

# ELECTRICAL DATA

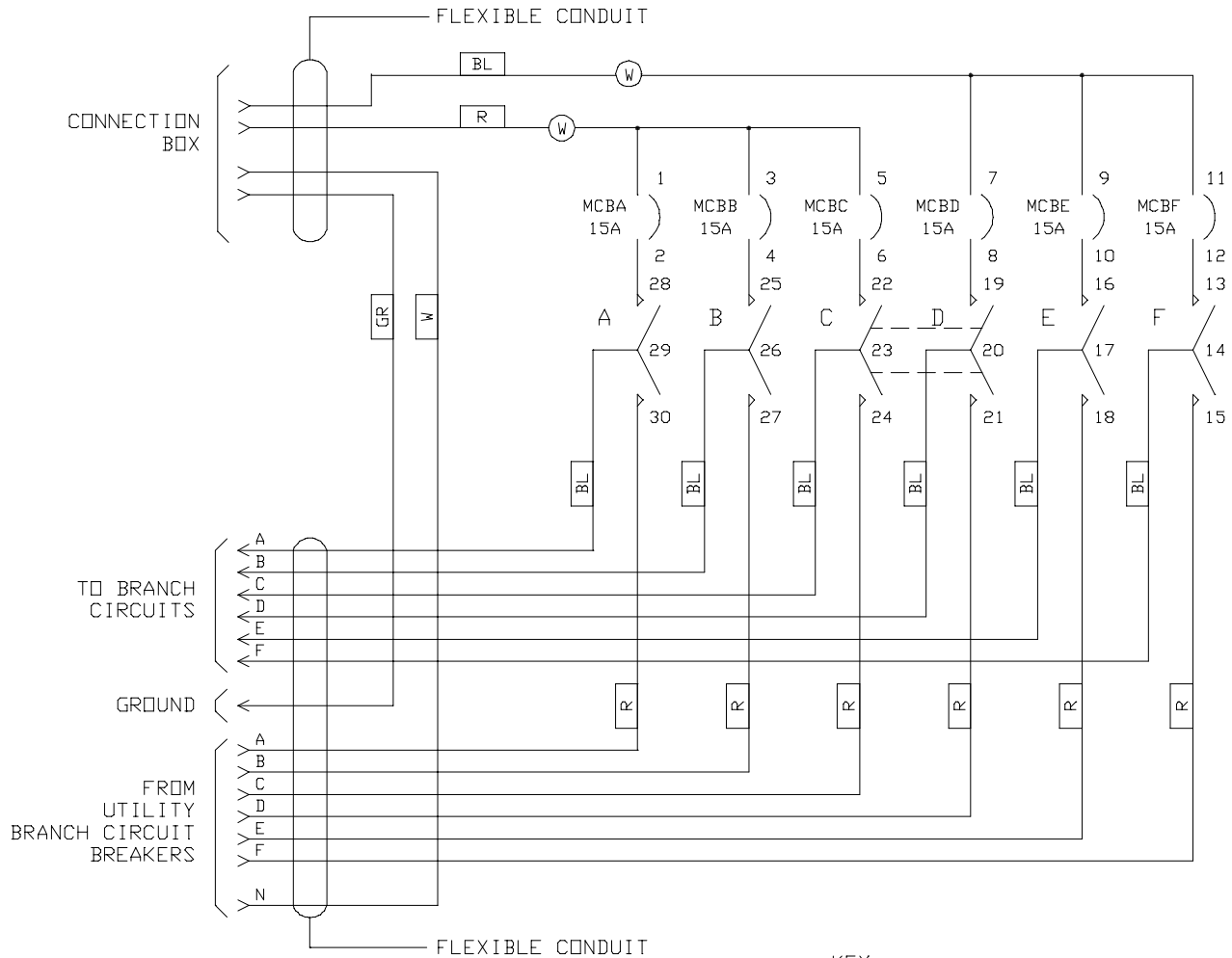

KEY

MCBA-F - MINIATURE  
CIRCUIT  
BREAKERS

A-F - 3-POSITION  
CHANGEDOVER  
SWITCHES

(W) - WATTMETER  
3600 WATTS  
@ 120 VOLTS

COLOUR CODE

BL - BLACK  
GR - GREEN  
R - RED  
W - WHITE

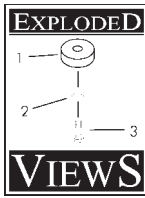

# EXPLODED VIEW AND PARTS LIST

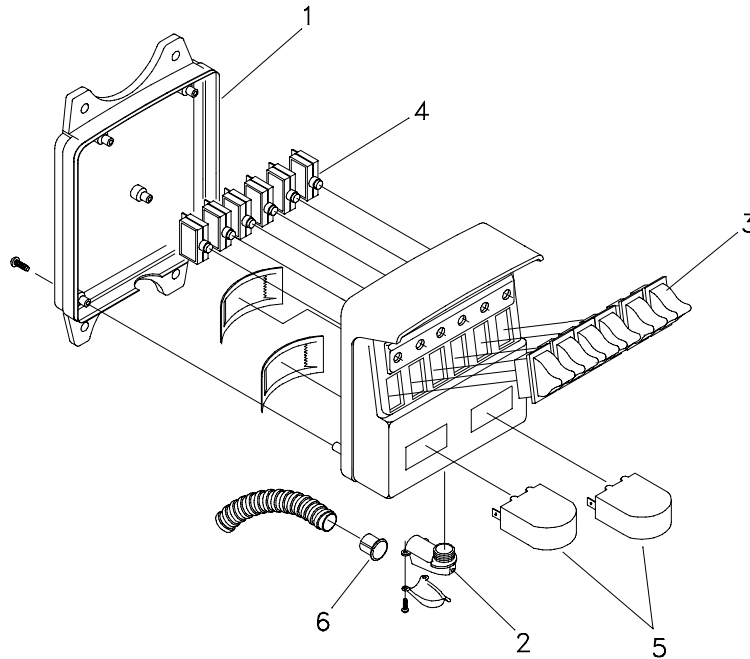

Item	Part No.	Qty.	Description
1	20030	1	COMPLETE ENCLOSURE, Front & Back
2	39271	1	CONNECTOR, 90 Degree
3	98927	1	ASSY., Switch, 3 Position

Item	Part No.	Qty.	Description
4	99151	1	ASSY., Circuit Breaker, 15 Amp
5	B4603	2	METER, 30 Amp, 3600 Watt
6	B5683	2	BUSHING, Anti Short

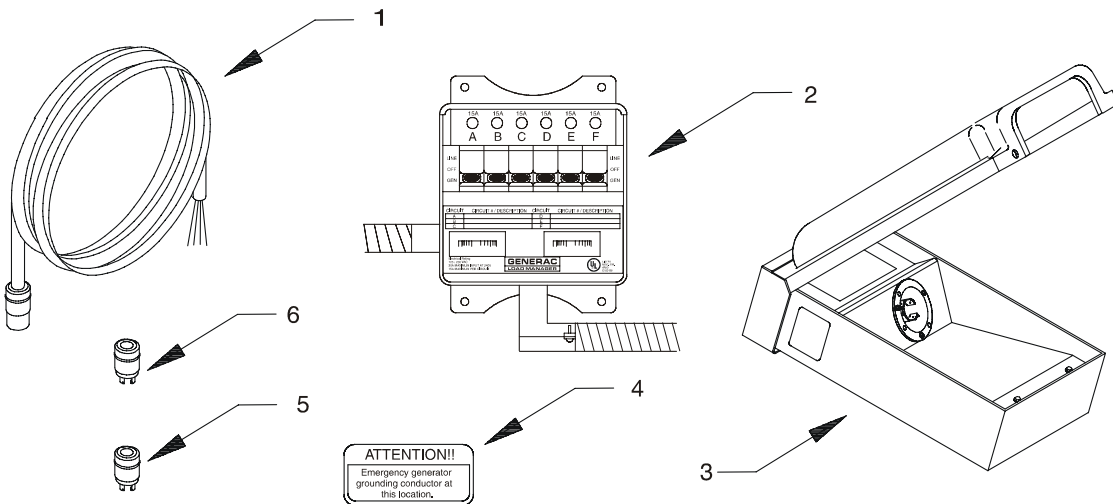

Item	Part No.	Qty.	Description
1	B3284	1	CORD SET, Connecting
2	97774	1	SWITCH, Load Manager™
3	B3298	1	BOX, Connecting

Item	Part No.	Qty.	Description
4	B4626	1	DECAL, Attention
5	B4208	1	PLUG, Connecting, 20 Amp
6	43438	1	PLUG, Connecting, 30 Amp



## OPERATING PROCEDURE

The Load Manager™ switch is equipped with six three-position switches. The switch positions labeled “LINE” are used for connecting the essential devices to the utility power source. The switch positions labeled “OFF” are used for load management. The switch positions labeled “GEN” are used for connecting desired circuits to the generator power source. The following sections describe appropriate use of these Load Manager™ switches.

### Switch To Generator Power

To switch to generator power after a utility power failure:

1. Ensure all Load Manager™ switches are in “LINE” position, as shown in Figure 21.

Figure 21 — Switches in LINE Position

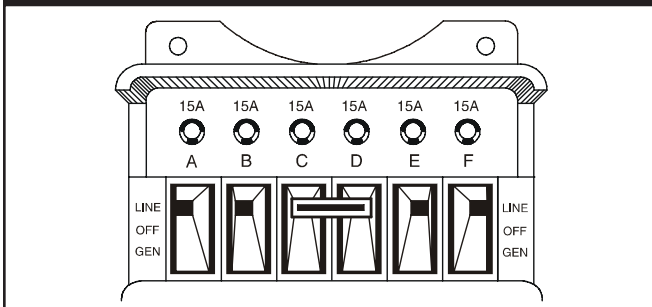

2. Align the female socket of the connecting cord set with the connection box receptacle's mating male prongs, as shown in Figure 22. Push cord set connector in and twist clockwise to lock.
3. Align the male prongs on the other end of the cord set with the mating female terminals of the generator's 240V receptacle, as shown in Figure 23. Push in connector and twist clockwise to lock.
4. Ensure generator is outdoors and fluids and fuel are topped-off.
5. Start the generator using instructions given in the generator owner's manual.

Figure 22 — Connection Box Connection



Figure 23 — Align Connectors at Generator





- At the Load Manager™ switch, switch desired circuits from “LINE” position to “GEN” position (as shown in Figure 24).

Figure 24 — All Switches in GEN Position

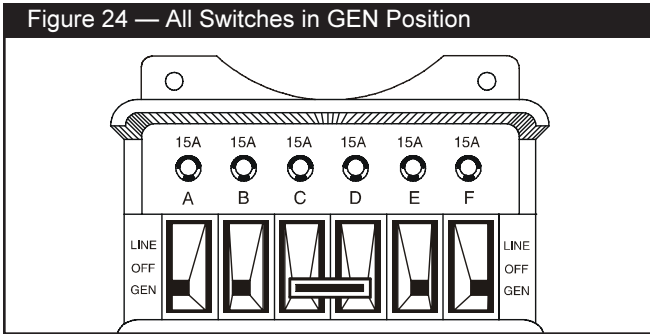

### Load Management

The number of circuits that can be operated simultaneously during a utility failure will depend on the wattage capacity of your generator. **Most portable generators do not have the capacity to handle loads on all Load Manager™ switch circuits at the same time.**

Review the load management plan developed with the installer (see “Plan the Installation”). It may be necessary to selectively turn on and off certain loads while using generator power so that necessary appliances can be operated safely.

The watt meters provided on the Load Manager™ monitor the current draw through each set of three circuits. For example, circuits “A”, “B”, and “C” are monitored by the lower left meter. When switching loads to the GEN position, watch the watt meter to ensure that maximum current levels are not exceeded and that each meter’s load is similar (balanced).

### Switch To Utility Power

**To revert from generator power to utility power after utility power is restored:**

- At the Load Manager™ switch, place all switches in “LINE” position, as shown previously in Figure 21.
- Shut off the generator.
- Disconnect the connecting cord set from the generator and the connection box.

### Testing

**Following installation and periodically thereafter, test the power transfer system as follows:**

- Ensure that all Load Manager™ switches are at “LINE” position (see Figure 21).
- Connect the connection cord set to the house connector box (see Figure 22).
- At the generator, connect the other end of the connection cord set to the generator (see Figure 23).
- Start the generator.
- At the Load Manager™ switch, set the “A” switch to “GEN” position, as shown in Figure 25. Verify that the “A” circuit load is operating properly. Return the “A” switch to the “LINE” position.

Figure 25 — “A” Switch in GEN Position

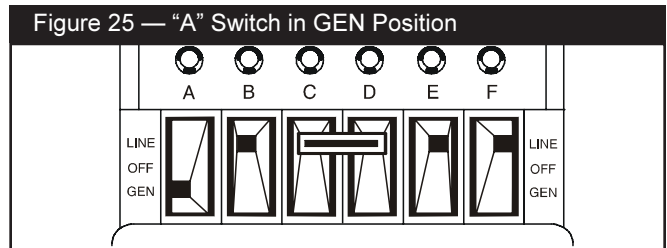

- Repeat Step 5, above, for each of the other load management circuits.

### Circuit Breakers in Load Manager™ Switch

Individual Load Manager™ switch circuits “A” through “F” are each protected by a 15 Amp circuit breaker. These breakers are labeled “A”, “B”, “C”, and so forth, as seen in Figure 25, for example. If an electrical load on one of these circuits exceeds 15 Amperes, the Load Manager™ switch circuit breaker will open.

**To reset the Load Manager™ switch breaker:**

- Eliminate the overload condition.
- Place the switch with the tripped circuit breaker in the “OFF” or middle position.
- Press in the circuit breaker button and observe that the button remains in.
- Place the switch that was in the OFF position back to GEN (or LINE, if that is what is desired).



## TROUBLESHOOTING

<b>Problem</b>	<b>Cause</b>	<b>Solution</b>
<b>Generator is running, but no AC output is available.</b>	<ol style="list-style-type: none"> <li>1. Generator circuit breaker is open.</li> <li>2. Poor connection or defective cord set.</li> <li>3. Connected device is bad.</li> <li>4. Fault in generator.</li> </ol>	<ol style="list-style-type: none"> <li>1. Reset circuit breaker.</li> <li>2. Check and repair.</li> <li>3. Select a different appliance or load that is in good condition.</li> <li>4. Contact authorized service center.</li> </ol>
<b>Generator runs good but bogs down when loads are connected.</b>	<ol style="list-style-type: none"> <li>1. Short circuit in a connected load.</li> <li>2. Generator is overloaded.</li> </ol>	<ol style="list-style-type: none"> <li>1. Disconnect shorted electrical load.</li> <li>2. See "Load Management" on page 14.</li> </ol>
<b>All Load Manager™ switches do not work when on generator power.</b>	<ol style="list-style-type: none"> <li>1. Load management switches in OFF or LINE positions.</li> <li>2. Generator circuit breaker is open.</li> <li>3. Poor connection or defective cord set.</li> <li>4. Connected device is bad.</li> <li>5. Fault in generator.</li> </ol>	<ol style="list-style-type: none"> <li>1. Set Load Manager™ switches in GEN position.</li> <li>2. Reset circuit breaker.</li> <li>3. Check and repair.</li> <li>4. Select a different appliance or load that is in good condition.</li> <li>5. Contact authorized service center.</li> </ol>
<b>Appliances don't work after utility power comes back on.</b>	<ol style="list-style-type: none"> <li>1. Load management switch in OFF or GEN position.</li> <li>2. Load management switch circuit breaker(s) is open.</li> </ol>	<ol style="list-style-type: none"> <li>1. Set switch to LINE position.</li> <li>2. Reset circuit breaker. See "Circuit Breakers in Load Manager™ Switch" section, page 14.</li> </ol>
<b>Only some loads work on generator power.</b>	Load management switch circuit breaker is open.	Reset circuit breaker. See "Circuit Breakers in Load Manager™ Switch" section, page 14.
<b>Wattmeter overloaded.</b>	Connected loads on circuits exceed 3600 watts.	Reduce loads on circuits.

# LIMITED WARRANTY

## One Year Limited Warranty

---

Generac Portable Products (hereafter referred to as the COMPANY), warrants to the original purchaser that this Power Transfer System will be free from defects in material and or workmanship for a period of one year from date of original sale. To register Power Transfer System ownership, the Owner's Registration card must be completed and returned to the COMPANY by the installer (licensed electrician or qualified professional). Any equipment that the buyer claims to be defective in material and or workmanship must be examined by a licensed electrician or qualified professional who is familiar with local electrical codes. The COMPANY will, at its option, repair and/or replace any part which is found by the COMPANY to be defective under normal use and service. All transportation costs under this warranty, including return to the factory, are to be borne and prepaid by the purchaser.

## Warranty Schedule

---

**Year One - 100% for all components (as listed in manual)**

All warranty expense allowances are subject to the conditions as defined in the published COMPANY Policies and Procedures Manual.

### **This Warranty Shall Not Apply To:**

1. Power Transfer Systems NOT installed by a licensed electrician or qualified professional.
2. Cost of installation or start-up.
3. Travel expenses of individuals performing repairs.
4. Units used as demonstrators or rentals.
5. Failures due to (a) normal wear and tear, or (b) accident, misuse, abuse, negligence, or improper installation.

Incidental, consequential, or indirect damages caused by defects in material or workmanship, or any costs associated with the delay in repair or replacement of the defective parts.

THIS WARRANTY REPLACES ALL PREVIOUS POWER TRANSFER SYSTEM WARRANTIES, EXPRESS OR IMPLIED. SPECIFICALLY, THE COMPANY MAKES NO OTHER WARRANTIES AS TO MERCHANTABILITY OR FITNESS FOR A PARTICULAR PURPOSE. THE COMPANY'S ONLY LIABILITY SHALL BE THE REPAIR AND/OR REPLACEMENT OF PARTS AS STATED ABOVE. IN NO EVENT SHALL THE COMPANY BE LIABLE FOR ANY INCIDENTAL OR CONSEQUENTIAL DAMAGES.

**Generac Portable Products**

Jefferson, Wisconsin U.S. A.